



CDS 101/110: Lecture 8-1 PID Control



Richard M. Murray
16 November 2015

Goals:

- Show how to use “loop shaping” using PID to achieve a performance specification
- Discuss the use of integral feedback and antiwindup compensation

Reading:

- Åström and Murray, Feedback Systems, Ch 10

Overview: PID control

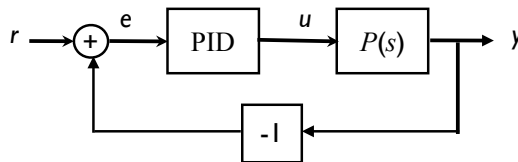

$$u = k_p e + k_i \int e dt + k_d \dot{e}$$

Intuition

- Proportional term: provides inputs that correct for “current” errors
- Integral term: insures steady state error goes to zero
- Derivative term: provides “anticipation” of upcoming changes

A bit of history on “three term control”

- First appeared in 1922 paper by Minorsky: “Directional stability of automatically steered bodies” under the name “three term control”
- Also realized that “small deviations” (linearization) could be used to understand the (nonlinear) system dynamics under control

Utility of PID

- PID control is most common feedback structure in engineering systems
- For many systems, only need PI or PD (special case)
- Many tools for tuning PID loops and designing gains

Proportional Feedback

Simplest controller choice: $u = k_p e$

- Effect: lifts gain with no change in phase
- Good for plants with low phase up to desired bandwidth
- Bode: shift gain up by factor of k_p
- Step response: better steady state error, but with decreasing stability

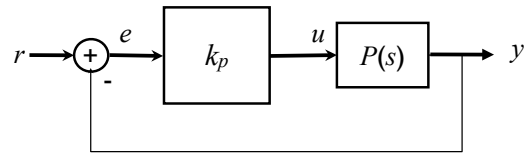

$$k_p > 0$$

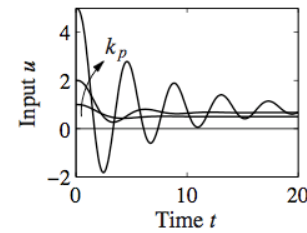
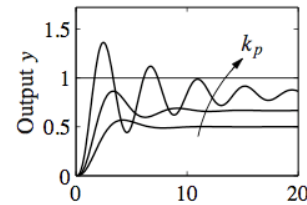
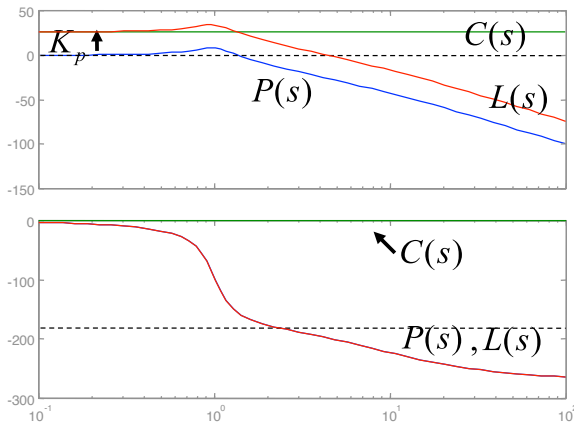

Proportional + Integral Compensation

Use to eliminate steady state error

- Effect: lifts gain at low frequency
- Gives zero steady state error
- Bode: infinite SS gain + phase lag
- Step response: zero steady state error, with smaller settling time, but more overshoot

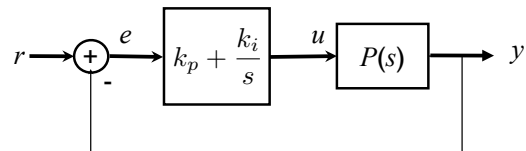

$$k_p > 0, \quad k_i > 0$$

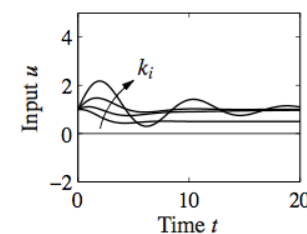
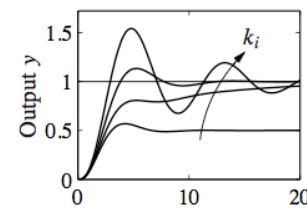
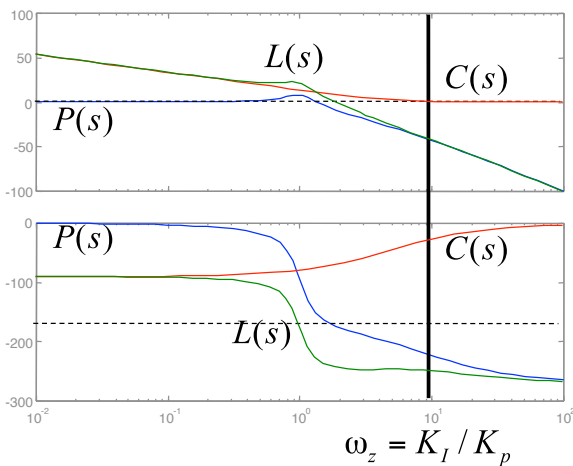

Proportional + Integral + Derivative (PID)

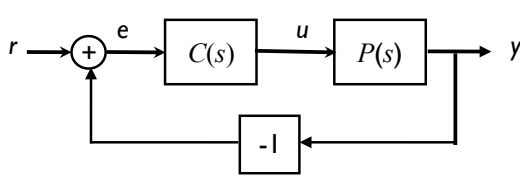

$$\begin{aligned}
 C(s) &= k_p + k_i \frac{1}{s} + k_d s \\
 &= k \left(1 + \frac{1}{T_i s} + T_d s \right) \\
 &= \frac{k T_d}{T_i} \frac{(s + 1/T_i)(s + 1/T_d)}{s}
 \end{aligned}$$

Bode Diagrams

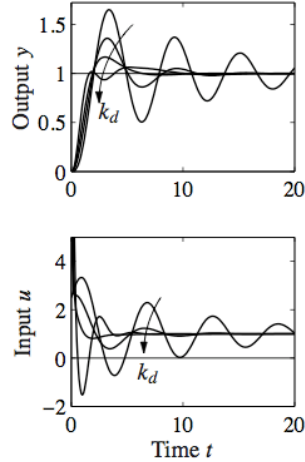
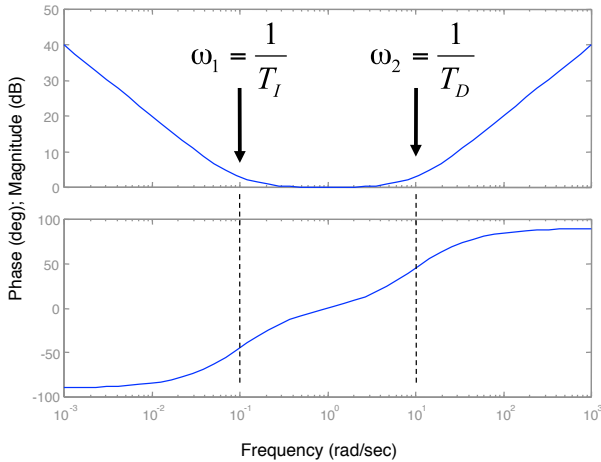

Implementing Derivative Action

Problems with derivatives

- High frequency noise amplified by derivative term
- Step inputs in reference can cause large inputs
- Show up in Gang of Four...

Solution: modified PID control

- Use high frequency rolloff in derivative term
 - first order filter will give finite gain at high frequency
 - use higher order filter if needed
- Don't feed reference signal through derivative block
 - Useful when reference has unwanted high frequency content
 - Better solution: reference shaping via two DOF design (F(s) block)
- Many other variations (see AM08 + refs)

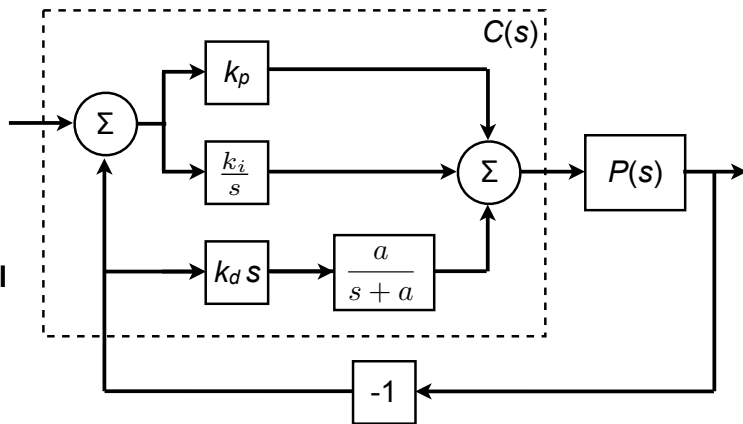

Bode Diagrams

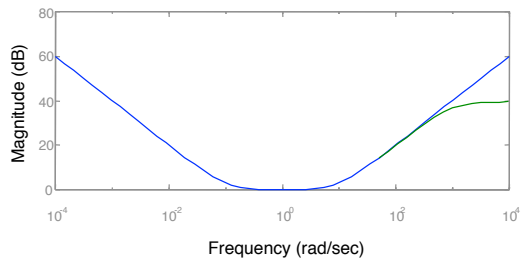

Example: Cruise Control using PID - Specification

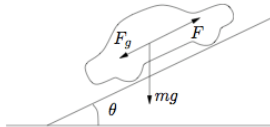

$$P(s) = \frac{1/m}{s + b/m} \times \frac{r}{s + a}$$

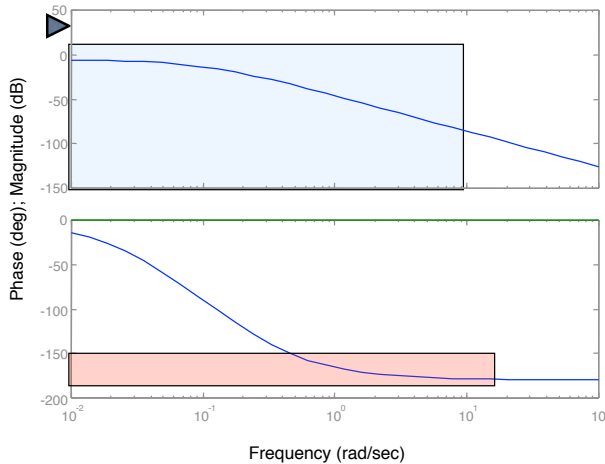

Performance Specification

- $\leq 1\%$ steady state error
 - Zero frequency gain > 100
- $\leq 10\%$ tracking error up to 10 rad/sec
 - Gain > 10 from 0-10 rad/sec
- $\geq 45^\circ$ phase margin
 - Gives good relative stability
 - Provides robustness to uncertainty

Observations

- Purely proportional gain won't work: to get gain above desired level will not leave adequate phase margin
- Need to increase the phase from ~ 0.5 to 2 rad/sec and increase gain as well

Example: Cruise Control using PID - Design

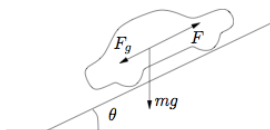

$$P(s) = \frac{1/m}{s + b/m} \times \frac{r}{s + a}$$

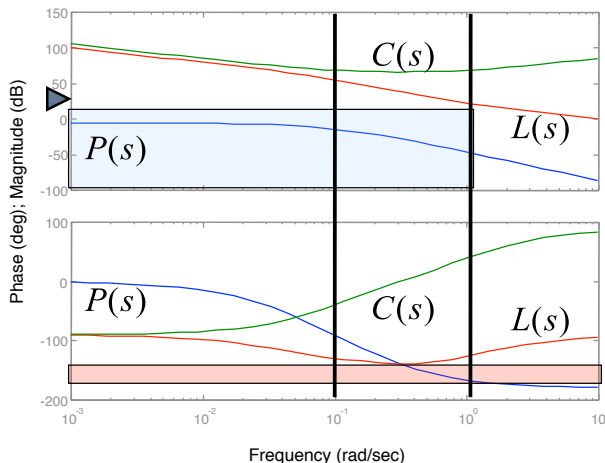

Approach

- Use integral gain to make steady state error small (zero, in fact)
- Use derivative action to increase phase lead in the cross over region
- Use proportional gain to give desired bandwidth

Controller

- $T_i = 1/0.1$; $T_d = 1/1$; $k = 2000$

$$C(s) = 2000 \frac{s^2 + 1.1s + 0.1}{s}$$

$$= 2200 + \frac{200}{s} + 2000s$$

Closed loop system

- Very high steady state gain
- Adequate tracking @ 1 rad/sec
- $\sim 80^\circ$ phase margin
- Verify with Nyquist

Example: Cruise Control using PID - Verification

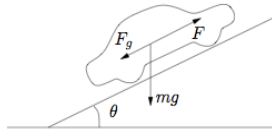

$$P(s) = \frac{1/m}{s + b/m} \times \frac{r}{s + a}$$

$$C(s) = 2000 \frac{s^2 + 1.1s + 0.1}{s}$$

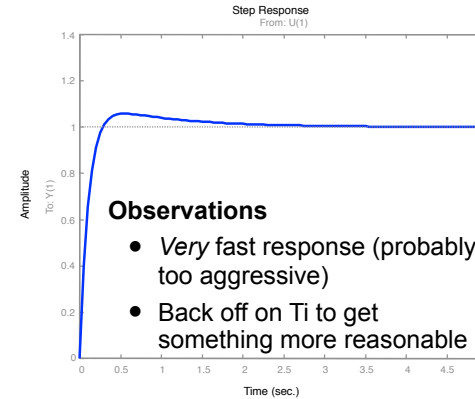
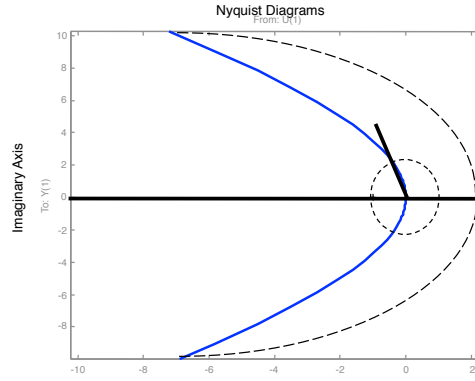
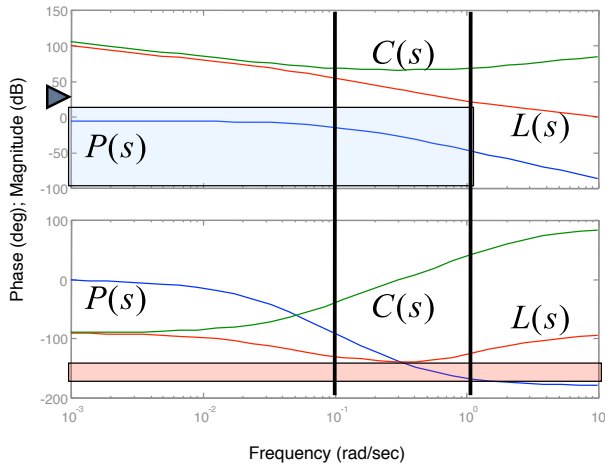

PID Tuning

Zeigler-Nichols step response method

- Design PID gains based on step response
- Measure maximum slope + intercept
- Works OK for many plants (but underdamped)
- Good way to get a first cut controller

Zeigler-Nichols frequency response method

- Increase gain until system goes unstable
- Use critical gain and frequency as parameters

Variations

- Modified formulas (see text) give better response
- Relay feedback: provides automated way to obtain critical gain, frequency

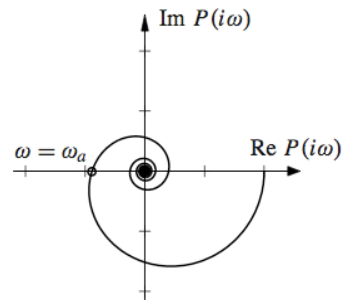
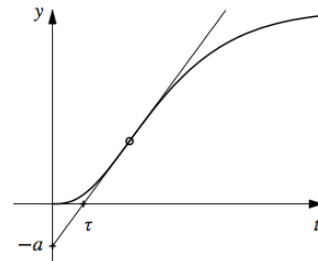

Type	k_p	T_i	T_d
P	$1/a$		
PI	$0.9/a$	3τ	
PID	$1.2/a$	2τ	0.5τ

(a) Step response method

Type	k_p	T_i	T_d
P	$0.5k_c$		
PI	$0.4k_c$	$0.8T_c$	
PID	$0.6k_c$	$0.5T_c$	$0.125T_c$

(b) Frequency response method

$$k_p = \frac{0.15\tau + 0.35T}{K\tau} \left(\frac{0.9T}{K\tau} \right), \quad k_i = \frac{0.46\tau + 0.02T}{K\tau^2} \left(\frac{0.3T}{K\tau^2} \right),$$

$$k_p = 0.22k_c - \frac{0.07}{K} \left(0.4k_c \right), \quad k_i = \frac{0.16k_c}{T_c} + \frac{0.62}{KT_c} \left(\frac{0.5k_c}{T_c} \right).$$

Example: PID cruise control

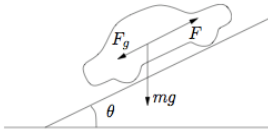

$$P(s) = \frac{1/m}{s + b/m} \times \frac{r}{s + a}$$

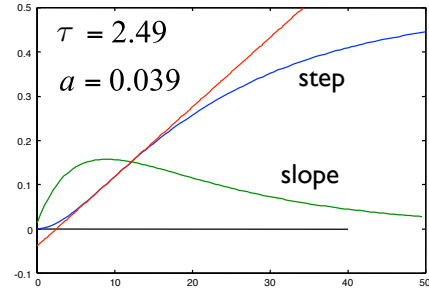

Ziegler-Nichols design for cruise controller

- Plot step response, extract τ and a , compute gains

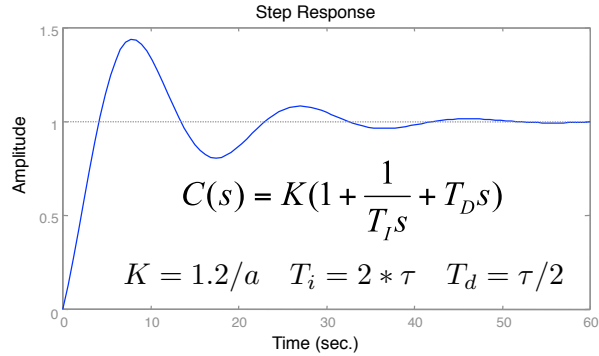
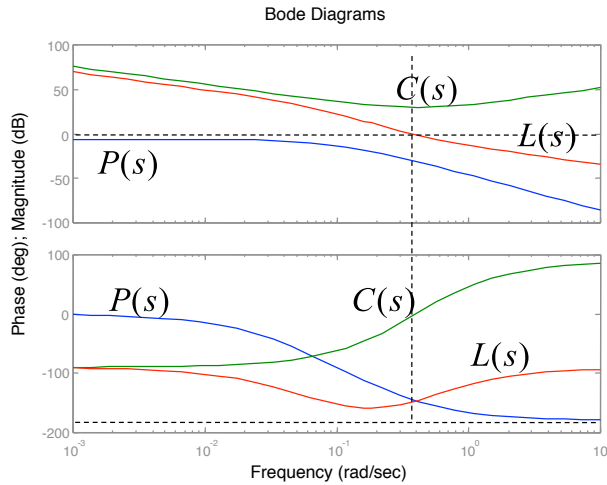

- Result: *sluggish* \Rightarrow increase loop gain + more phase margine (shift zero)

Windup and Anti-Windup Compensation

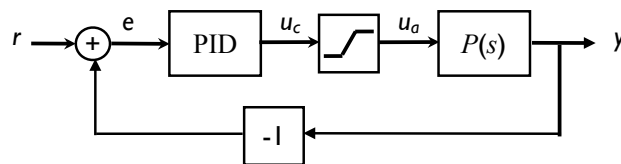
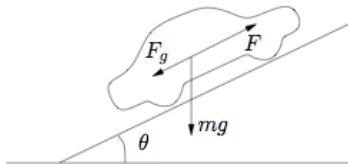

Problem

- Limited magnitude input (saturation)
- Integrator "winds up" \Rightarrow overshoot

Solution

- Compare commanded input to actual
- Subtract off difference from integrator

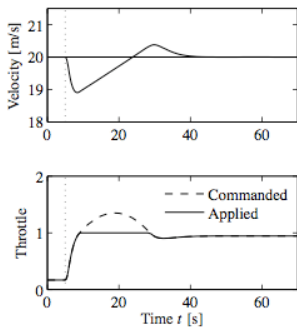

(a) Windup

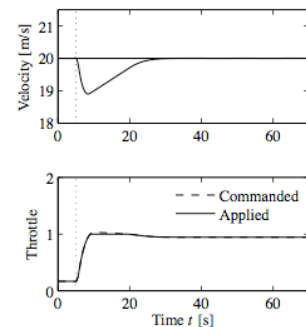
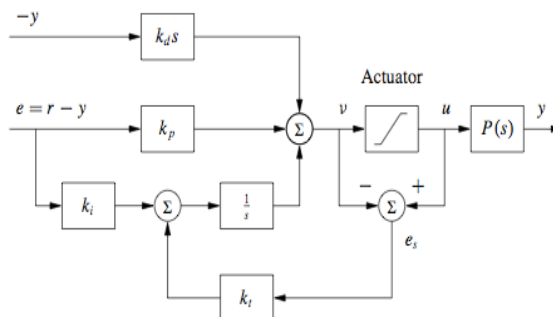

(b) Anti-windup

Summary: Frequency Domain Design using PID

Loop Shaping for Stability & Performance

- Steady state error, bandwidth, tracking

$$H_{ue}(s) = K_p + K_I \frac{1}{s} + K_D s$$

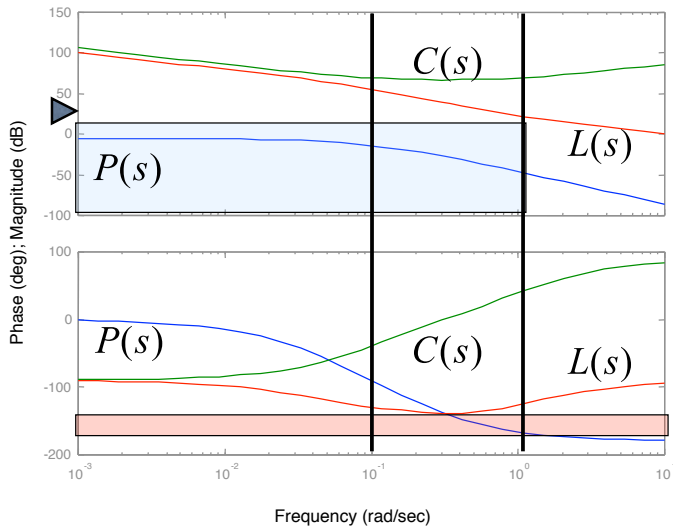

Main ideas

- Performance specs give bounds on loop transfer function
- Use controller to shape response
- Gain/phase relationships constrain design approach
- Standard compensators: proportional, PI, PID

