

---

## Chapter Four

### Dynamic Behavior

*It Don't Mean a Thing If It Ain't Got That Swing.*

Duke Ellington (1899–1974)

In this chapter we present a broad discussion of the behavior of dynamical systems focused on systems modeled by nonlinear differential equations. This allows us to consider equilibrium points, stability, limit cycles and other key concepts in understanding dynamic behavior. We also introduce some methods for analyzing the global behavior of solutions.

#### 4.1 Solving Differential Equations

In the last two chapters we saw that one of the methods of modeling dynamical systems is through the use of ordinary differential equations (ODEs). A state space, input/output system has the form

$$\frac{dx}{dt} = f(x, u), \quad y = h(x, u), \quad (4.1)$$

where  $x = (x_1, \dots, x_n) \in \mathbb{R}^n$  is the state,  $u \in \mathbb{R}^p$  is the input and  $y \in \mathbb{R}^q$  is the output. The smooth maps  $f : \mathbb{R}^n \times \mathbb{R}^p \rightarrow \mathbb{R}^n$  and  $h : \mathbb{R}^n \times \mathbb{R}^p \rightarrow \mathbb{R}^q$  represent the dynamics and measurements for the system. In general, they can be nonlinear functions of their arguments. We will sometimes focus on single-input, single-output (SISO) systems, for which  $p = q = 1$ .

We begin by investigating systems in which the input has been set to a function of the state,  $u = \alpha(x)$ . This is one of the simplest types of feedback, in which the system regulates its own behavior. The differential equations in this case become

$$\frac{dx}{dt} = f(x, \alpha(x)) =: F(x). \quad (4.2)$$

To understand the dynamic behavior of this system, we need to analyze the features of the solutions of equation (4.2). While in some simple situations we can write down the solutions in analytical form, often we must rely on computational approaches. We begin by describing the class of solutions for this problem.

We say that  $x(t)$  is a *solution* of the differential equation (4.2) on the time interval  $t_0 \in \mathbb{R}$  to  $t_f \in \mathbb{R}$  if

$$\frac{dx(t)}{dt} = F(x(t)) \quad \text{for all } t_0 < t < t_f.$$

A given differential equation may have many solutions. We will most often be interested in the *initial value problem*, where  $x(t)$  is prescribed at a given time  $t_0 \in \mathbb{R}$  and we wish to find a solution valid for all *future* time  $t > t_0$ .

We say that  $x(t)$  is a solution of the differential equation (4.2) with initial value  $x_0 \in \mathbb{R}^n$  at  $t_0 \in \mathbb{R}$  if

$$x(t_0) = x_0 \quad \text{and} \quad \frac{dx(t)}{dt} = F(x(t)) \quad \text{for all } t_0 < t < t_f.$$

For most differential equations we will encounter, there is a *unique* solution that is defined for  $t_0 < t < t_f$ . The solution may be defined for all time  $t > t_0$ , in which case we take  $t_f = \infty$ . Because we will primarily be interested in solutions of the initial value problem for ODEs, we will usually refer to this simply as the solution of an ODE.

We will typically assume that  $t_0$  is equal to 0. In the case when  $F$  is independent of time (as in equation (4.2)), we can do so without loss of generality by choosing a new independent (time) variable,  $\tau = t - t_0$  (Exercise 4.1).

#### Example 4.1 Damped oscillator

Consider a damped linear oscillator with dynamics of the form

$$\ddot{q} + 2\zeta\omega_0\dot{q} + \omega_0^2q = 0,$$

where  $q$  is the displacement of the oscillator from its rest position. These dynamics are equivalent to those of a spring–mass system, as shown in Exercise 2.6. We assume that  $\zeta < 1$ , corresponding to a lightly damped system (the reason for this particular choice will become clear later). We can rewrite this in state space form by setting  $x_1 = q$  and  $x_2 = \dot{q}/\omega_0$ , giving

$$\frac{dx_1}{dt} = \omega_0 x_2, \quad \frac{dx_2}{dt} = -\omega_0 x_1 - 2\zeta\omega_0 x_2.$$

In vector form, the right-hand side can be written as

$$F(x) = \begin{bmatrix} \omega_0 x_2 \\ -\omega_0 x_1 - 2\zeta\omega_0 x_2 \end{bmatrix}.$$

The solution to the initial value problem can be written in a number of different ways and will be explored in more detail in Chapter 5. Here we simply assert that the solution can be written as

$$\begin{aligned} x_1(t) &= e^{-\zeta\omega_0 t} \left( x_{10} \cos \omega_d t + \frac{1}{\omega_d} (\omega_0 \zeta x_{10} + x_{20}) \sin \omega_d t \right), \\ x_2(t) &= e^{-\zeta\omega_0 t} \left( x_{20} \cos \omega_d t - \frac{1}{\omega_d} (\omega_0^2 x_{10} + \omega_0 \zeta x_{20}) \sin \omega_d t \right), \end{aligned}$$

where  $x_0 = (x_{10}, x_{20})$  is the initial condition and  $\omega_d = \omega_0 \sqrt{1 - \zeta^2}$ . This solution can be verified by substituting it into the differential equation. We see that the solution is explicitly dependent on the initial condition, and it can be shown that this solution is unique. A plot of the initial condition response is shown in Figure 4.1.

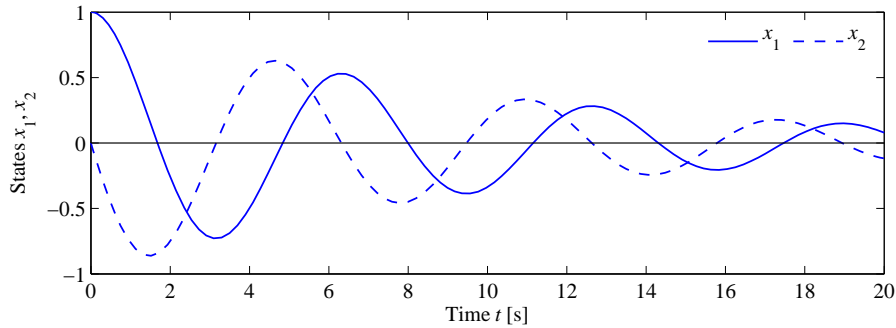

**Figure 4.1:** Response of the damped oscillator to the initial condition  $x_0 = (1, 0)$ . The solution is unique for the given initial conditions and consists of an oscillatory solution for each state, with an exponentially decaying magnitude.

We note that this form of the solution holds only for  $0 < \zeta < 1$ , corresponding to an “underdamped” oscillator.  $\nabla$

Without imposing some mathematical conditions on the function  $F$ , the differential equation (4.2) may not have a solution for all  $t$ , and there is no guarantee that the solution is unique. We illustrate these possibilities with two examples.  $\diamond$

#### Example 4.2 Finite escape time

Let  $x \in \mathbb{R}$  and consider the differential equation

$$\frac{dx}{dt} = x^2 \quad (4.3)$$

with the initial condition  $x(0) = 1$ . By differentiation we can verify that the function

$$x(t) = \frac{1}{1-t} \quad (4.4)$$

satisfies the differential equation and that it also satisfies the initial condition. A graph of the solution is given in Figure 4.2a; notice that the solution goes to infinity as  $t$  goes to 1. We say that this system has *finite escape time*. Thus the solution exists only in the time interval  $0 \leq t < 1$ .  $\nabla$

#### Example 4.3 Nonunique solution

Let  $x \in \mathbb{R}$  and consider the differential equation

$$\frac{dx}{dt} = 2\sqrt{x}$$

with initial condition  $x(0) = 0$ . We can show that the function

$$x(t) = \begin{cases} 0 & \text{if } 0 \leq t \leq a \\ (t-a)^2 & \text{if } t > a \end{cases}$$

satisfies the differential equation for all values of the parameter  $a \geq 0$ . To see this,

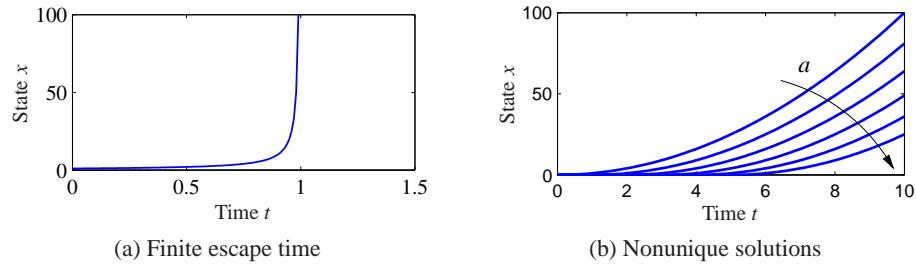

**Figure 4.2:** Existence and uniqueness of solutions. Equation (4.3) has a solution only for time  $t < 1$ , at which point the solution goes to  $\infty$ , as shown in (a). Equation (4.4) is an example of a system with many solutions, as shown in (b). For each value of  $a$ , we get a different solution starting from the same initial condition.

we differentiate  $x(t)$  to obtain

$$\frac{dx}{dt} = \begin{cases} 0 & \text{if } 0 \leq t \leq a \\ 2(t - a) & \text{if } t > a, \end{cases}$$

and hence  $\dot{x} = 2\sqrt{x}$  for all  $t \geq 0$  with  $x(0) = 0$ . A graph of some of the possible solutions is given in Figure 4.2b. Notice that in this case there are many solutions to the differential equation.  $\nabla$

These simple examples show that there may be difficulties even with simple differential equations. Existence and uniqueness can be guaranteed by requiring that the function  $F$  have the property that for some fixed  $c \in \mathbb{R}$ ,

$$\|F(x) - F(y)\| < c\|x - y\| \quad \text{for all } x, y,$$

which is called *Lipschitz continuity*. A sufficient condition for a function to be Lipschitz is that the Jacobian  $\partial F/\partial x$  is uniformly bounded for all  $x$ . The difficulty in Example 4.2 is that the derivative  $\partial F/\partial x$  becomes large for large  $x$ , and the difficulty in Example 4.3 is that the derivative  $\partial F/\partial x$  is infinite at the origin.

## 4.2 Qualitative Analysis

The qualitative behavior of nonlinear systems is important in understanding some of the key concepts of stability in nonlinear dynamics. We will focus on an important class of systems known as planar dynamical systems. These systems have two state variables  $x \in \mathbb{R}^2$ , allowing their solutions to be plotted in the  $(x_1, x_2)$  plane. The basic concepts that we describe hold more generally and can be used to understand dynamical behavior in higher dimensions.

### Phase Portraits

A convenient way to understand the behavior of dynamical systems with state  $x \in \mathbb{R}^2$  is to plot the phase portrait of the system, briefly introduced in Chapter 2.

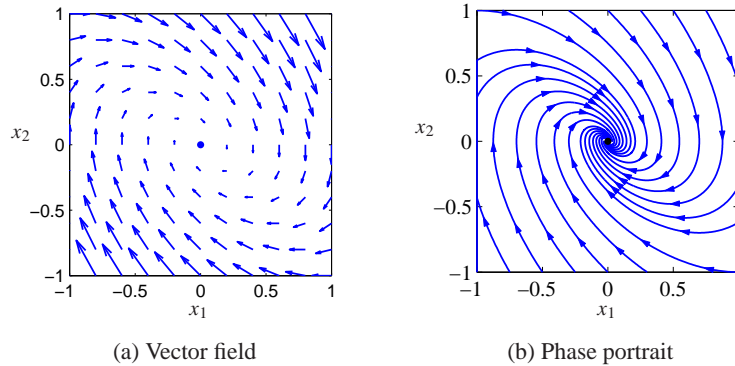

**Figure 4.3:** Phase portraits. (a) This plot shows the vector field for a planar dynamical system. Each arrow shows the velocity at that point in the state space. (b) This plot includes the solutions (sometimes called streamlines) from different initial conditions, with the vector field superimposed.

We start by introducing the concept of a *vector field*. For a system of ordinary differential equations

$$\frac{dx}{dt} = F(x),$$

the right-hand side of the differential equation defines at every  $x \in \mathbb{R}^n$  a velocity  $F(x) \in \mathbb{R}^n$ . This velocity tells us how  $x$  changes and can be represented as a vector  $F(x) \in \mathbb{R}^n$ .

For planar dynamical systems, each state corresponds to a point in the plane and  $F(x)$  is a vector representing the velocity of that state. We can plot these vectors on a grid of points in the plane and obtain a visual image of the dynamics of the system, as shown in Figure 4.3a. The points where the velocities are zero are of particular interest since they define stationary points of the flow: if we start at such a state, we stay at that state.

A *phase portrait* is constructed by plotting the flow of the vector field corresponding to the planar dynamical system. That is, for a set of initial conditions, we plot the solution of the differential equation in the plane  $\mathbb{R}^2$ . This corresponds to following the arrows at each point in the phase plane and drawing the resulting trajectory. By plotting the solutions for several different initial conditions, we obtain a phase portrait, as shown in Figure 4.3b. Phase portraits are also sometimes called *phase plane diagrams*.

Phase portraits give insight into the dynamics of the system by showing the solutions plotted in the (two-dimensional) state space of the system. For example, we can see whether all trajectories tend to a single point as time increases or whether there are more complicated behaviors. In the example in Figure 4.3, corresponding to a damped oscillator, the solutions approach the origin for all initial conditions. This is consistent with our simulation in Figure 4.1, but it allows us to infer the behavior for all initial conditions rather than a single initial condition. However, the phase portrait does not readily tell us the rate of change of the states (although

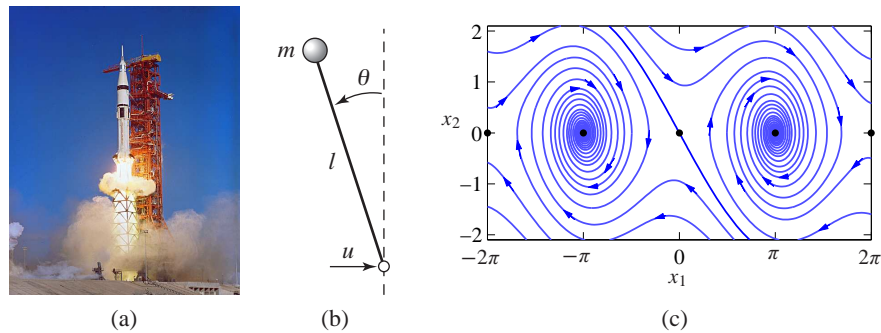

**Figure 4.4:** Equilibrium points for an inverted pendulum. An inverted pendulum is a model for a class of balance systems in which we wish to keep a system upright, such as a rocket (a). Using a simplified model of an inverted pendulum (b), we can develop a phase portrait that shows the dynamics of the system (c). The system has multiple equilibrium points, marked by the solid dots along the  $x_2 = 0$  line.

this can be inferred from the lengths of the arrows in the vector field plot).

### Equilibrium Points and Limit Cycles

An *equilibrium point* of a dynamical system represents a stationary condition for the dynamics. We say that a state  $x_e$  is an equilibrium point for a dynamical system

$$\frac{dx}{dt} = F(x)$$

if  $F(x_e) = 0$ . If a dynamical system has an initial condition  $x(0) = x_e$ , then it will stay at the equilibrium point:  $x(t) = x_e$  for all  $t \geq 0$ , where we have taken  $t_0 = 0$ .

Equilibrium points are one of the most important features of a dynamical system since they define the states corresponding to constant operating conditions. A dynamical system can have zero, one or more equilibrium points.

#### Example 4.4 Inverted pendulum

Consider the inverted pendulum in Figure 4.4, which is a part of the balance system we considered in Chapter 2. The inverted pendulum is a simplified version of the problem of stabilizing a rocket: by applying forces at the base of the rocket, we seek to keep the rocket stabilized in the upright position. The state variables are the angle  $\theta = x_1$  and the angular velocity  $d\theta/dt = x_2$ , the control variable is the acceleration  $u$  of the pivot and the output is the angle  $\theta$ .

For simplicity we assume that  $mgl/J_t = 1$  and  $ml/J_t = 1$ , so that the dynamics (equation (2.10)) become

$$\frac{dx}{dt} = \begin{bmatrix} x_2 \\ \sin x_1 - cx_2 + u \cos x_1 \end{bmatrix}. \quad (4.5)$$

This is a nonlinear time-invariant system of second order. This same set of equations can also be obtained by appropriate normalization of the system dynamics as illustrated in Example 2.7.

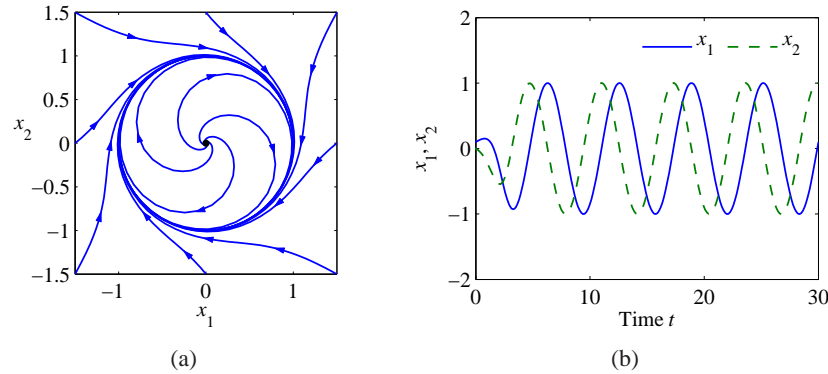

**Figure 4.5:** Phase portrait and time domain simulation for a system with a limit cycle. The phase portrait (a) shows the states of the solution plotted for different initial conditions. The limit cycle corresponds to a closed loop trajectory. The simulation (b) shows a single solution plotted as a function of time, with the limit cycle corresponding to a steady oscillation of fixed amplitude.

We consider the open loop dynamics by setting  $u = 0$ . The equilibrium points for the system are given by

$$x_e = \begin{bmatrix} \pm n\pi \\ 0 \end{bmatrix},$$

where  $n = 0, 1, 2, \dots$ . The equilibrium points for  $n$  even correspond to the pendulum pointing up and those for  $n$  odd correspond to the pendulum hanging down. A phase portrait for this system (without corrective inputs) is shown in Figure 4.4c. The phase portrait shows  $-2\pi \leq x_1 \leq 2\pi$ , so five of the equilibrium points are shown.  $\nabla$

Nonlinear systems can exhibit rich behavior. Apart from equilibria they can also exhibit stationary periodic solutions. This is of great practical value in generating sinusoidally varying voltages in power systems or in generating periodic signals for animal locomotion. A simple example is given in Exercise 4.12, which shows the circuit diagram for an electronic oscillator. A normalized model of the oscillator is given by the equation

$$\frac{dx_1}{dt} = x_2 + x_1(1 - x_1^2 - x_2^2), \quad \frac{dx_2}{dt} = -x_1 + x_2(1 - x_1^2 - x_2^2). \quad (4.6)$$

The phase portrait and time domain solutions are given in Figure 4.5. The figure shows that the solutions in the phase plane converge to a circular trajectory. In the time domain this corresponds to an oscillatory solution. Mathematically the circle is called a *limit cycle*. More formally, we call an isolated solution  $x(t)$  a limit cycle of period  $T > 0$  if  $x(t + T) = x(t)$  for all  $t \in \mathbb{R}$ .

There are methods for determining limit cycles for second-order systems, but for general higher-order systems we have to resort to computational analysis. Computer algorithms find limit cycles by searching for periodic trajectories in state space that

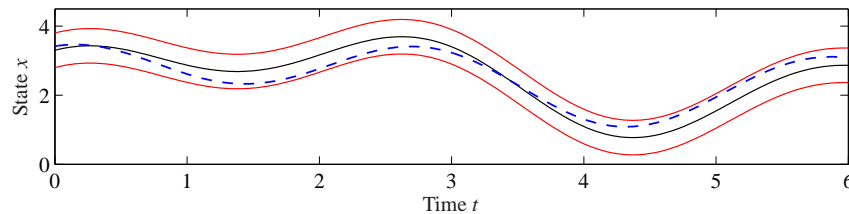

**Figure 4.6:** Illustration of Lyapunov's concept of a stable solution. The solution represented by the solid line is stable if we can guarantee that all solutions remain within a tube of diameter  $\epsilon$  by choosing initial conditions sufficiently close the solution.

satisfy the dynamics of the system. In many situations, stable limit cycles can be found by simulating the system with different initial conditions.

### 4.3 Stability

The stability of a solution determines whether or not solutions nearby the solution remain close, get closer or move further away. We now give a formal definition of stability and describe tests for determining whether a solution is stable.

#### Definitions

Let  $x(t; a)$  be a solution to the differential equation with initial condition  $a$ . A solution is *stable* if other solutions that start near  $a$  stay close to  $x(t; a)$ . Formally, we say that the solution  $x(t; a)$  is stable if for all  $\epsilon > 0$ , there exists a  $\delta > 0$  such that

$$\|b - a\| < \delta \implies \|x(t; b) - x(t; a)\| < \epsilon \quad \text{for all } t > 0.$$

Note that this definition does not imply that  $x(t; b)$  approaches  $x(t; a)$  as time increases but just that it stays nearby. Furthermore, the value of  $\delta$  may depend on  $\epsilon$ , so that if we wish to stay very close to the solution, we may have to start very, very close ( $\delta \ll \epsilon$ ). This type of stability, which is illustrated in Figure 4.6, is also called *stability in the sense of Lyapunov*. If a solution is stable in this sense and the trajectories do not converge, we say that the solution is *neutrally stable*.

An important special case is when the solution  $x(t; a) = x_e$  is an equilibrium solution. Instead of saying that the solution is stable, we simply say that the equilibrium point is stable. An example of a neutrally stable equilibrium point is shown in Figure 4.7. From the phase portrait, we see that if we start near the equilibrium point, then we stay near the equilibrium point. Indeed, for this example, given any  $\epsilon$  that defines the range of possible initial conditions, we can simply choose  $\delta = \epsilon$  to satisfy the definition of stability since the trajectories are perfect circles.

A solution  $x(t; a)$  is *asymptotically stable* if it is stable in the sense of Lyapunov and also  $x(t; b) \rightarrow x(t; a)$  as  $t \rightarrow \infty$  for  $b$  sufficiently close to  $a$ . This corresponds to the case where all nearby trajectories converge to the stable solution for large time. Figure 4.8 shows an example of an asymptotically stable equilibrium point. Note



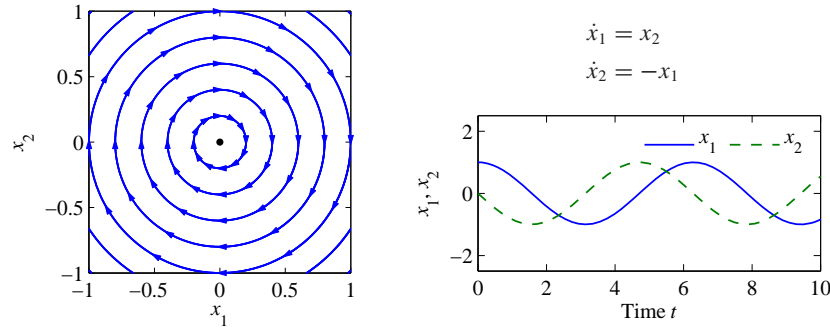

**Figure 4.7:** Phase portrait and time domain simulation for a system with a single stable equilibrium point. The equilibrium point  $x_e$  at the origin is stable since all trajectories that start near  $x_e$  stay near  $x_e$ .

from the phase portraits that not only do all trajectories stay near the equilibrium point at the origin, but that they also all approach the origin as  $t$  gets large (the directions of the arrows on the phase portrait show the direction in which the trajectories move).

A solution  $x(t; a)$  is *unstable* if it is not stable. More specifically, we say that a solution  $x(t; a)$  is unstable if given some  $\epsilon > 0$ , there does *not* exist a  $\delta > 0$  such that if  $\|b - a\| < \delta$ , then  $\|x(t; b) - x(t; a)\| < \epsilon$  for all  $t$ . An example of an unstable equilibrium point is shown in Figure 4.9.

The definitions above are given without careful description of their domain of applicability. More formally, we define a solution to be *locally stable* (or *locally asymptotically stable*) if it is stable for all initial conditions  $x \in B_r(a)$ , where

$$B_r(a) = \{x : \|x - a\| < r\}$$

is a ball of radius  $r$  around  $a$  and  $r > 0$ . A system is *globally stable* if it is stable for all  $r > 0$ . Systems whose equilibrium points are only locally stable can have

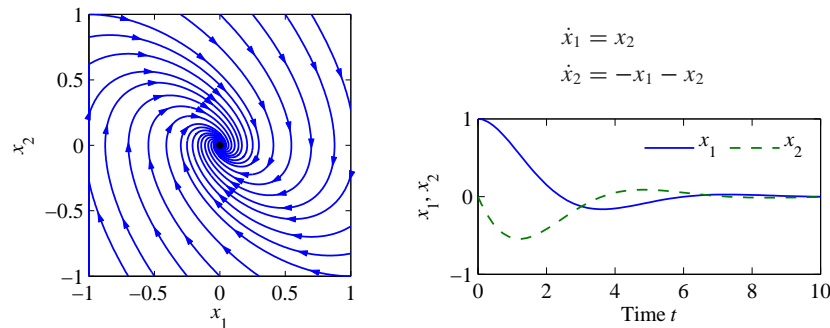

**Figure 4.8:** Phase portrait and time domain simulation for a system with a single asymptotically stable equilibrium point. The equilibrium point  $x_e$  at the origin is asymptotically stable since the trajectories converge to this point as  $t \rightarrow \infty$ .

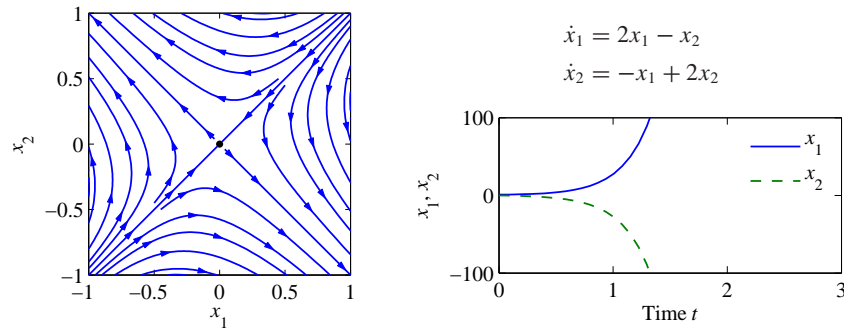

**Figure 4.9:** Phase portrait and time domain simulation for a system with a single unstable equilibrium point. The equilibrium point  $x_e$  at the origin is unstable since not all trajectories that start near  $x_e$  stay near  $x_e$ . The sample trajectory on the right shows that the trajectories very quickly depart from zero.

interesting behavior away from equilibrium points, as we explore in the next section.

For planar dynamical systems, equilibrium points have been assigned names based on their stability type. An asymptotically stable equilibrium point is called a *sink* or sometimes an *attractor*. An unstable equilibrium point can be either a *source*, if all trajectories lead away from the equilibrium point, or a *saddle*, if some trajectories lead to the equilibrium point and others move away (this is the situation pictured in Figure 4.9). Finally, an equilibrium point that is stable but not asymptotically stable (i.e., neutrally stable, such as the one in Figure 4.7) is called a *center*.

#### Example 4.5 Congestion control

The model for congestion control in a network consisting of  $N$  identical computers connected to a single router, introduced in Section 3.4, is given by

$$\frac{dw}{dt} = \frac{c}{b} - \rho c \left(1 + \frac{w^2}{2}\right), \quad \frac{db}{dt} = N \frac{wc}{b} - c,$$

where  $w$  is the window size and  $b$  is the buffer size of the router. Phase portraits are shown in Figure 4.10 for two different sets of parameter values. In each case we see that the system converges to an equilibrium point in which the buffer is below its full capacity of 500 packets. The equilibrium size of the buffer represents a balance between the transmission rates for the sources and the capacity of the link. We see from the phase portraits that the equilibrium points are asymptotically stable since all initial conditions result in trajectories that converge to these points.  $\nabla$

#### Stability of Linear Systems

A linear dynamical system has the form

$$\frac{dx}{dt} = Ax, \quad x(0) = x_0, \quad (4.7)$$

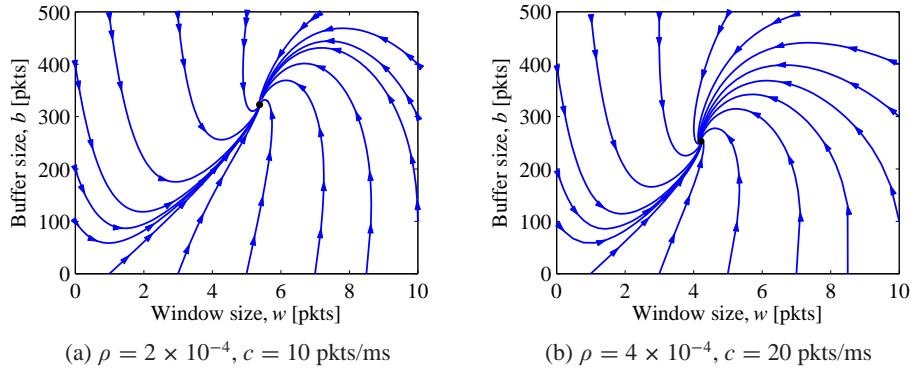

**Figure 4.10:** Phase portraits for a congestion control protocol running with  $N = 60$  identical source computers. The equilibrium values correspond to a fixed window at the source, which results in a steady-state buffer size and corresponding transmission rate. A faster link (b) uses a smaller buffer size since it can handle packets at a higher rate.

where  $A \in \mathbb{R}^{n \times n}$  is a square matrix, corresponding to the dynamics matrix of a linear control system (2.6). For a linear system, the stability of the equilibrium at the origin can be determined from the eigenvalues of the matrix  $A$ :

$$\lambda(A) = \{s \in \mathbb{C} : \det(sI - A) = 0\}.$$

The polynomial  $\det(sI - A)$  is the *characteristic polynomial* and the eigenvalues are its roots. We use the notation  $\lambda_j$  for the  $j$ th eigenvalue of  $A$ , so that  $\lambda_j \in \lambda(A)$ . In general  $\lambda$  can be complex-valued, although if  $A$  is real-valued, then for any eigenvalue  $\lambda$ , its complex conjugate  $\lambda^*$  will also be an eigenvalue. The origin is always an equilibrium for a linear system. Since the stability of a linear system depends only on the matrix  $A$ , we find that stability is a property of the system. For a linear system we can therefore talk about the stability of the system rather than the stability of a particular solution or equilibrium point.

The easiest class of linear systems to analyze are those whose system matrices are in diagonal form. In this case, the dynamics have the form

$$\frac{dx}{dt} = \begin{bmatrix} \lambda_1 & & 0 \\ & \lambda_2 & \\ & & \ddots \\ 0 & & & \lambda_n \end{bmatrix} x. \quad (4.8)$$

It is easy to see that the state trajectories for this system are independent of each other, so that we can write the solution in terms of  $n$  individual systems  $\dot{x}_j = \lambda_j x_j$ . Each of these scalar solutions is of the form

$$x_j(t) = e^{\lambda_j t} x(0).$$

We see that the equilibrium point  $x_e = 0$  is stable if  $\lambda_j \leq 0$  and asymptotically stable if  $\lambda_j < 0$ .

Another simple case is when the dynamics are in the block diagonal form

$$\frac{dx}{dt} = \begin{bmatrix} \sigma_1 & \omega_1 & 0 & 0 \\ -\omega_1 & \sigma_1 & 0 & 0 \\ 0 & 0 & \ddots & \vdots \\ 0 & 0 & \sigma_m & \omega_m \\ 0 & 0 & -\omega_m & \sigma_m \end{bmatrix} x.$$

In this case, the eigenvalues can be shown to be  $\lambda_j = \sigma_j \pm i\omega_j$ . We once again can separate the state trajectories into independent solutions for each pair of states, and the solutions are of the form

$$\begin{aligned} x_{2j-1}(t) &= e^{\sigma_j t} (x_{2j-1}(0) \cos \omega_j t + x_{2j}(0) \sin \omega_j t), \\ x_{2j}(t) &= e^{\sigma_j t} (-x_{2j-1}(0) \sin \omega_j t + x_{2j}(0) \cos \omega_j t), \end{aligned}$$

where  $j = 1, 2, \dots, m$ . We see that this system is asymptotically stable if and only if  $\sigma_j = \operatorname{Re} \lambda_j < 0$ . It is also possible to combine real and complex eigenvalues in (block) diagonal form, resulting in a mixture of solutions of the two types.

Very few systems are in one of the diagonal forms above, but some systems can be transformed into these forms via coordinate transformations. One such class of systems is those for which the dynamics matrix has distinct (nonrepeating) eigenvalues. In this case there is a matrix  $T \in \mathbb{R}^{n \times n}$  such that the matrix  $TAT^{-1}$  is in (block) diagonal form, with the block diagonal elements corresponding to the eigenvalues of the original matrix  $A$  (see Exercise 4.14). If we choose new coordinates  $z = Tx$ , then

$$\frac{dz}{dt} = T\dot{x} = TAx = TAT^{-1}z$$

and the linear system has a (block) diagonal dynamics matrix. Furthermore, the eigenvalues of the transformed system are the same as the original system since if  $v$  is an eigenvector of  $A$ , then  $w = Tv$  can be shown to be an eigenvector of  $TAT^{-1}$ . We can reason about the stability of the original system by noting that  $x(t) = T^{-1}z(t)$ , and so if the transformed system is stable (or asymptotically stable), then the original system has the same type of stability.

This analysis shows that for linear systems with distinct eigenvalues, the stability of the system can be completely determined by examining the real part of the eigenvalues of the dynamics matrix. For more general systems, we make use of the following theorem, proved in the next chapter:

**Theorem 4.1** (Stability of a linear system). *The system*

$$\frac{dx}{dt} = Ax$$

*is asymptotically stable if and only if all eigenvalues of  $A$  all have a strictly negative real part and is unstable if any eigenvalue of  $A$  has a strictly positive real part.*

**Example 4.6 Compartment model**

Consider the two-compartment model for drug delivery introduced in Section 3.6.

Using concentrations as state variables and denoting the state vector by  $x$ , the system dynamics are given by

$$\frac{dx}{dt} = \begin{bmatrix} -k_0 - k_1 & k_1 \\ k_2 & -k_2 \end{bmatrix} x + \begin{bmatrix} b_0 \\ 0 \end{bmatrix} u, \quad y = \begin{bmatrix} 0 & 1 \end{bmatrix} x,$$

where the input  $u$  is the rate of injection of a drug into compartment 1 and the concentration of the drug in compartment 2 is the measured output  $y$ . We wish to design a feedback control law that maintains a constant output given by  $y = y_d$ .

We choose an output feedback control law of the form

$$u = -k(y - y_d) + u_d,$$

where  $u_d$  is the rate of injection required to maintain the desired concentration and  $k$  is a feedback gain that should be chosen such that the closed loop system is stable. Substituting the control law into the system, we obtain

$$\begin{aligned} \frac{dx}{dt} &= \begin{bmatrix} -k_0 - k_1 & k_1 - b_0k \\ k_2 & -k_2 \end{bmatrix} x + \begin{bmatrix} b_0 \\ 0 \end{bmatrix} u_d =: Ax + Bu_d, \\ y &= \begin{bmatrix} 0 & 1 \end{bmatrix} x =: Cx. \end{aligned}$$

The equilibrium concentration  $x_e \in \mathbb{R}^2$  is given by  $x_e = -A^{-1}Bu_d$  and

$$y_e = -CA^{-1}Bu_d = \frac{b_0k_2}{k_0k_2 + b_0k_2k}u_d.$$

Choosing  $u_d$  such that  $y_e = y_d$  provides the constant rate of injection required to maintain the desired output. We can now shift coordinates to place the equilibrium point at the origin, which yields

$$\frac{dz}{dt} = \begin{bmatrix} -k_0 - k_1 & k_1 - b_0k \\ k_2 & -k_2 \end{bmatrix} z,$$

where  $z = x - x_e$ . We can now apply the results of Theorem 4.1 to determine the stability of the system. The eigenvalues of the system are given by the roots of the characteristic polynomial

$$\lambda(s) = s^2 + (k_0 + k_1 + k_2)s + (k_0k_2 + b_0k_2k).$$

While the specific form of the roots is messy, it can be shown that the roots are positive as long as the linear term and the constant term are both positive (Exercise 4.16). Hence the system is stable for any  $k > 0$ .  $\nabla$

### Stability Analysis via Linear Approximation

An important feature of differential equations is that it is often possible to determine the local stability of an equilibrium point by approximating the system by a linear system. The following example illustrates the basic idea.

**Example 4.7 Inverted pendulum**

Consider again an inverted pendulum whose open loop dynamics are given by

$$\frac{dx}{dt} = \begin{bmatrix} x_2 \\ \sin x_1 - \gamma x_2 \end{bmatrix},$$

where we have defined the state as  $x = (\theta, \dot{\theta})$ . We first consider the equilibrium point at  $x = (0, 0)$ , corresponding to the straight-up position. If we assume that the angle  $\theta = x_1$  remains small, then we can replace  $\sin x_1$  with  $x_1$  and  $\cos x_1$  with 1, which gives the approximate system

$$\frac{dx}{dt} = \begin{bmatrix} x_2 \\ x_1 - \gamma x_2 \end{bmatrix} = \begin{bmatrix} 0 & 1 \\ 1 & -\gamma \end{bmatrix} x. \quad (4.9)$$

Intuitively, this system should behave similarly to the more complicated model as long as  $x_1$  is small. In particular, it can be verified that the equilibrium point  $(0, 0)$  is unstable by plotting the phase portrait or computing the eigenvalues of the dynamics matrix in equation (4.9)

We can also approximate the system around the stable equilibrium point at  $x = (\pi, 0)$ . In this case we have to expand  $\sin x_1$  and  $\cos x_1$  around  $x_1 = \pi$ , according to the expansions

$$\sin(\pi + \theta) = -\sin \theta \approx -\theta, \quad \cos(\pi + \theta) = -\cos(\theta) \approx -1.$$

If we define  $z_1 = x_1 - \pi$  and  $z_2 = x_2$ , the resulting approximate dynamics are given by

$$\frac{dz}{dt} = \begin{bmatrix} z_2 \\ -z_1 - \gamma z_2 \end{bmatrix} = \begin{bmatrix} 0 & 1 \\ -1 & -\gamma \end{bmatrix} z. \quad (4.10)$$

Note that  $z = (0, 0)$  is the equilibrium point for this system and that it has the same basic form as the dynamics shown in Figure 4.8. Figure 4.11 shows the phase portraits for the original system and the approximate system around the corresponding equilibrium points. Note that they are very similar, although not exactly the same. It can be shown that if a linear approximation has either asymptotically stable or unstable equilibrium points, then the local stability of the original system must be the same (Theorem 4.3).  $\nabla$

More generally, suppose that we have a nonlinear system

$$\frac{dx}{dt} = F(x)$$

that has an equilibrium point at  $x_e$ . Computing the Taylor series expansion of the vector field, we can write

$$\frac{dx}{dt} = F(x_e) + \left. \frac{\partial F}{\partial x} \right|_{x_e} (x - x_e) + \text{higher-order terms in } (x - x_e).$$

Since  $F(x_e) = 0$ , we can approximate the system by choosing a new state variable

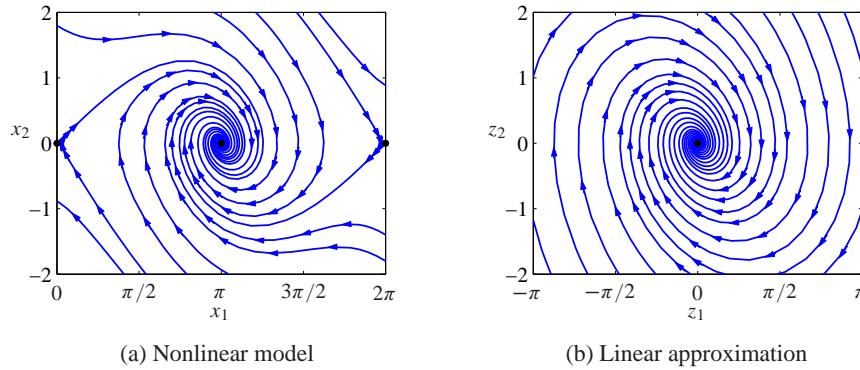

**Figure 4.11:** Comparison between the phase portraits for the full nonlinear systems (a) and its linear approximation around the origin (b). Notice that near the equilibrium point at the center of the plots, the phase portraits (and hence the dynamics) are almost identical.

$z = x - x_e$  and writing

$$\frac{dz}{dt} = Az, \quad \text{where } A = \left. \frac{\partial F}{\partial x} \right|_{x_e}. \quad (4.11)$$

We call the system (4.11) the *linear approximation* of the original nonlinear system or the *linearization* at  $x_e$ .

The fact that a linear model can be used to study the behavior of a nonlinear system near an equilibrium point is a powerful one. Indeed, we can take this even further and use a local linear approximation of a nonlinear system to design a feedback law that keeps the system near its equilibrium point (design of dynamics). Thus, feedback can be used to make sure that solutions remain close to the equilibrium point, which in turn ensures that the linear approximation used to stabilize it is valid.

Linear approximations can also be used to understand the stability of nonequilibrium solutions, as illustrated by the following example.

#### Example 4.8 Stable limit cycle

Consider the system given by equation (4.6),

$$\frac{dx_1}{dt} = x_2 + x_1(1 - x_1^2 - x_2^2), \quad \frac{dx_2}{dt} = -x_1 + x_2(1 - x_1^2 - x_2^2),$$

whose phase portrait is shown in Figure 4.5. The differential equation has a periodic solution

$$x_1(t) = x_1(0) \cos t + x_2(0) \sin t, \quad (4.12)$$

with  $x_1^2(0) + x_2^2(0) = 1$ .

To explore the stability of this solution, we introduce polar coordinates  $r$  and  $\varphi$ , which are related to the state variables  $x_1$  and  $x_2$  by

$$x_1 = r \cos \varphi, \quad x_2 = r \sin \varphi.$$

Differentiation gives the following linear equations for  $\dot{r}$  and  $\dot{\phi}$ :

$$\dot{x}_1 = \dot{r} \cos \phi - r \dot{\phi} \sin \phi, \quad \dot{x}_2 = \dot{r} \sin \phi + r \dot{\phi} \cos \phi.$$

Solving this linear system for  $\dot{r}$  and  $\dot{\phi}$  gives, after some calculation,

$$\frac{dr}{dt} = r(1 - r^2), \quad \frac{d\phi}{dt} = -1.$$

Notice that the equations are decoupled; hence we can analyze the stability of each state separately.

The equation for  $r$  has three equilibria:  $r = 0$ ,  $r = 1$  and  $r = -1$  (not realizable since  $r$  must be positive). We can analyze the stability of these equilibria by linearizing the radial dynamics with  $F(r) = r(1 - r^2)$ . The corresponding linear dynamics are given by

$$\frac{dr}{dt} = \left. \frac{\partial F}{\partial r} \right|_{r_e} r = (1 - 3r_e^2)r, \quad r_e = 0, 1,$$

where we have abused notation and used  $r$  to represent the deviation from the equilibrium point. It follows from the sign of  $(1 - 3r_e^2)$  that the equilibrium  $r = 0$  is unstable and the equilibrium  $r = 1$  is asymptotically stable. Thus for any initial condition  $r > 0$  the solution goes to  $r = 1$  as time goes to infinity, but if the system starts with  $r = 0$ , it will remain at the equilibrium for all times. This implies that all solutions to the original system that do not start at  $x_1 = x_2 = 0$  will approach the circle  $x_1^2 + x_2^2 = 1$  as time increases.

To show the stability of the full solution (4.12), we must investigate the behavior of neighboring solutions with different initial conditions. We have already shown that the radius  $r$  will approach that of the solution (4.12) as long as  $r(0) > 0$ . The equation for the angle  $\phi$  can be integrated analytically to give  $\phi(t) = -t + \phi(0)$ , which shows that solutions starting at different angles  $\phi$  will neither converge nor diverge. Thus, the unit circle is *attracting*, but the solution (4.12) is only stable, not asymptotically stable. The behavior of the system is illustrated by the simulation in Figure 4.12. Notice that the solutions approach the circle rapidly, but that there is a constant phase shift between the solutions.  $\nabla$



#### 4.4 Lyapunov Stability Analysis

We now return to the study of the full nonlinear system

$$\frac{dx}{dt} = F(x), \quad x \in \mathbb{R}^n. \quad (4.13)$$

Having defined when a solution for a nonlinear dynamical system is stable, we can now ask how to prove that a given solution is stable, asymptotically stable or unstable. For physical systems, one can often argue about stability based on dissipation of energy. The generalization of that technique to arbitrary dynamical systems is based on the use of Lyapunov functions in place of energy.



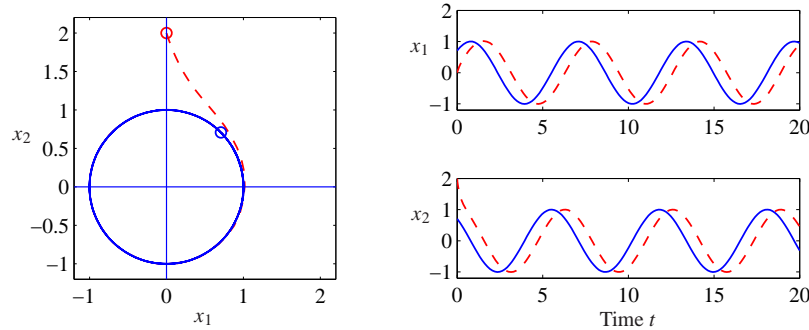

**Figure 4.12:** Solution curves for a stable limit cycle. The phase portrait on the left shows that the trajectory for the system rapidly converges to the stable limit cycle. The starting points for the trajectories are marked by circles in the phase portrait. The time domain plots on the right show that the states do not converge to the solution but instead maintain a constant phase error.

In this section we will describe techniques for determining the stability of solutions for a nonlinear system (4.13). We will generally be interested in stability of equilibrium points, and it will be convenient to assume that  $x_e = 0$  is the equilibrium point of interest. (If not, rewrite the equations in a new set of coordinates  $z = x - x_e$ .)

### Lyapunov Functions

A *Lyapunov function*  $V : \mathbb{R}^n \rightarrow \mathbb{R}$  is an energy-like function that can be used to determine the stability of a system. Roughly speaking, if we can find a nonnegative function that always decreases along trajectories of the system, we can conclude that the minimum of the function is a stable equilibrium point (locally).

To describe this more formally, we start with a few definitions. We say that a continuous function  $V$  is *positive definite* if  $V(x) > 0$  for all  $x \neq 0$  and  $V(0) = 0$ . Similarly, a function is *negative definite* if  $V(x) < 0$  for all  $x \neq 0$  and  $V(0) = 0$ . We say that a function  $V$  is *positive semidefinite* if  $V(x) \geq 0$  for all  $x$ , but  $V(x)$  can be zero at points other than just  $x = 0$ .

To illustrate the difference between a positive definite function and a positive semidefinite function, suppose that  $x \in \mathbb{R}^2$  and let

$$V_1(x) = x_1^2, \quad V_2(x) = x_1^2 + x_2^2.$$

Both  $V_1$  and  $V_2$  are always nonnegative. However, it is possible for  $V_1$  to be zero even if  $x \neq 0$ . Specifically, if we set  $x = (0, c)$ , where  $c \in \mathbb{R}$  is any nonzero number, then  $V_1(x) = 0$ . On the other hand,  $V_2(x) = 0$  if and only if  $x = (0, 0)$ . Thus  $V_1$  is positive semidefinite and  $V_2$  is positive definite.

We can now characterize the stability of an equilibrium point  $x_e = 0$  for the system (4.13).

**Theorem 4.2** (Lyapunov stability theorem). *Let  $V$  be a nonnegative function on*

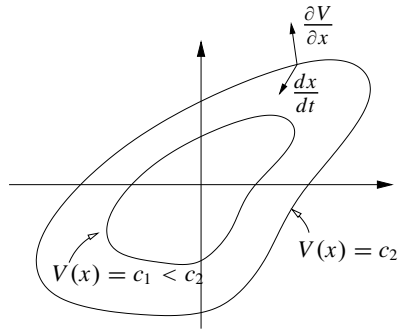

**Figure 4.13:** Geometric illustration of Lyapunov's stability theorem. The closed contours represent the level sets of the Lyapunov function  $V(x) = c$ . If  $dx/dt$  points inward to these sets at all points along the contour, then the trajectories of the system will always cause  $V(x)$  to decrease along the trajectory.

$\mathbb{R}^n$  and let  $\dot{V}$  represent the time derivative of  $V$  along trajectories of the system dynamics (4.13):

$$\dot{V} = \frac{\partial V}{\partial x} \frac{dx}{dt} = \frac{\partial V}{\partial x} F(x).$$

Let  $B_r = B_r(0)$  be a ball of radius  $r$  around the origin. If there exists  $r > 0$  such that  $V$  is positive definite and  $\dot{V}$  is negative semidefinite for all  $x \in B_r$ , then  $x = 0$  is locally stable in the sense of Lyapunov. If  $V$  is positive definite and  $\dot{V}$  is negative definite in  $B_r$ , then  $x = 0$  is locally asymptotically stable.

If  $V$  satisfies one of the conditions above, we say that  $V$  is a (local) *Lyapunov function* for the system. These results have a nice geometric interpretation. The level curves for a positive definite function are the curves defined by  $V(x) = c$ ,  $c > 0$ , and for each  $c$  this gives a closed contour, as shown in Figure 4.13. The condition that  $\dot{V}(x)$  is negative simply means that the vector field points toward lower-level contours. This means that the trajectories move to smaller and smaller values of  $V$  and if  $\dot{V}$  is negative definite then  $x$  must approach 0.

#### Example 4.9 Scalar nonlinear system

Consider the scalar nonlinear system

$$\frac{dx}{dt} = \frac{2}{1+x} - x.$$

This system has equilibrium points at  $x = 1$  and  $x = -2$ . We consider the equilibrium point at  $x = 1$  and rewrite the dynamics using  $z = x - 1$ :

$$\frac{dz}{dt} = \frac{2}{2+z} - z - 1,$$

which has an equilibrium point at  $z = 0$ . Now consider the candidate Lyapunov function

$$V(z) = \frac{1}{2}z^2,$$

which is globally positive definite. The derivative of  $V$  along trajectories of the system is given by

$$\dot{V}(z) = z\dot{z} = \frac{2z}{2+z} - z^2 - z.$$

If we restrict our analysis to an interval  $B_r$ , where  $r < 2$ , then  $2 + z > 0$  and we can multiply through by  $2 + z$  to obtain

$$2z - (z^2 + z)(2 + z) = -z^3 - 3z^2 = -z^2(z + 3) < 0, \quad z \in B_r, r < 2.$$

It follows that  $\dot{V}(z) < 0$  for all  $z \in B_r$ ,  $z \neq 0$ , and hence the equilibrium point  $x_e = 1$  is locally asymptotically stable.  $\nabla$

A slightly more complicated situation occurs if  $\dot{V}$  is negative semidefinite. In this case it is possible that  $\dot{V}(x) = 0$  when  $x \neq 0$ , and hence  $x$  could stop decreasing in value. The following example illustrates this case.

#### Example 4.10 Hanging pendulum

A normalized model for a hanging pendulum is

$$\frac{dx_1}{dt} = x_2, \quad \frac{dx_2}{dt} = -\sin x_1,$$

where  $x_1$  is the angle between the pendulum and the vertical, with positive  $x_1$  corresponding to counterclockwise rotation. The equation has an equilibrium  $x_1 = x_2 = 0$ , which corresponds to the pendulum hanging straight down. To explore the stability of this equilibrium we choose the total energy as a Lyapunov function:

$$V(x) = 1 - \cos x_1 + \frac{1}{2}x_2^2 \approx \frac{1}{2}x_1^2 + \frac{1}{2}x_2^2.$$

The Taylor series approximation shows that the function is positive definite for small  $x$ . The time derivative of  $V(x)$  is

$$\dot{V} = \dot{x}_1 \sin x_1 + \dot{x}_2 x_2 = x_2 \sin x_1 - x_2 \sin x_1 = 0.$$

Since this function is positive semidefinite, it follows from Lyapunov's theorem that the equilibrium is stable but not necessarily asymptotically stable. When perturbed, the pendulum actually moves in a trajectory that corresponds to constant energy.  $\nabla$

Lyapunov functions are not always easy to find, and they are not unique. In many cases energy functions can be used as a starting point, as was done in Example 4.10. It turns out that Lyapunov functions can always be found for any stable system (under certain conditions), and hence one knows that if a system is stable, a Lyapunov function exists (and vice versa). Recent results using sum-of-squares methods have provided systematic approaches for finding Lyapunov systems [PPP02]. Sum-of-squares techniques can be applied to a broad variety of systems, including systems whose dynamics are described by polynomial equations, as well as hybrid systems, which can have different models for different regions of state space.

For a linear dynamical system of the form

$$\frac{dx}{dt} = Ax,$$

it is possible to construct Lyapunov functions in a systematic manner. To do so, we consider quadratic functions of the form

$$V(x) = x^T P x,$$

where  $P \in \mathbb{R}^{n \times n}$  is a symmetric matrix ( $P = P^T$ ). The condition that  $V$  be positive definite is equivalent to the condition that  $P$  be a *positive definite matrix*:

$$x^T P x > 0, \quad \text{for all } x \neq 0,$$

which we write as  $P > 0$ . It can be shown that if  $P$  is symmetric, then  $P$  is positive definite if and only if all of its eigenvalues are real and positive.

Given a candidate Lyapunov function  $V(x) = x^T P x$ , we can now compute its derivative along flows of the system:

$$\dot{V} = \frac{\partial V}{\partial x} \frac{dx}{dt} = x^T (A^T P + P A)x =: -x^T Q x.$$

The requirement that  $\dot{V}$  be negative definite (for asymptotic stability) becomes a condition that the matrix  $Q$  be positive definite. Thus, to find a Lyapunov function for a linear system it is sufficient to choose a  $Q > 0$  and solve the *Lyapunov equation*:

$$A^T P + P A = -Q. \quad (4.14)$$

This is a linear equation in the entries of  $P$ , and hence it can be solved using linear algebra. It can be shown that the equation always has a solution if all of the eigenvalues of the matrix  $A$  are in the left half-plane. Moreover, the solution  $P$  is positive definite if  $Q$  is positive definite. It is thus always possible to find a quadratic Lyapunov function for a stable linear system. We will defer a proof of this until Chapter 5, where more tools for analysis of linear systems will be developed.

Knowing that we have a direct method to find Lyapunov functions for linear systems, we can now investigate the stability of nonlinear systems. Consider the system

$$\frac{dx}{dt} = F(x) =: Ax + \tilde{F}(x), \quad (4.15)$$

where  $F(0) = 0$  and  $\tilde{F}(x)$  contains terms that are second order and higher in the elements of  $x$ . The function  $Ax$  is an approximation of  $F(x)$  near the origin, and we can determine the Lyapunov function for the linear approximation and investigate if it is also a Lyapunov function for the full nonlinear system. The following example illustrates the approach.

#### Example 4.11 Genetic switch

Consider the dynamics of a set of repressors connected together in a cycle, as shown in Figure 4.14a. The normalized dynamics for this system were given in Exercise 2.9:

$$\frac{dz_1}{d\tau} = \frac{\mu}{1 + z_2^n} - z_1, \quad \frac{dz_2}{d\tau} = \frac{\mu}{1 + z_1^n} - z_2, \quad (4.16)$$

where  $z_1$  and  $z_2$  are scaled versions of the protein concentrations,  $n$  and  $\mu$  are

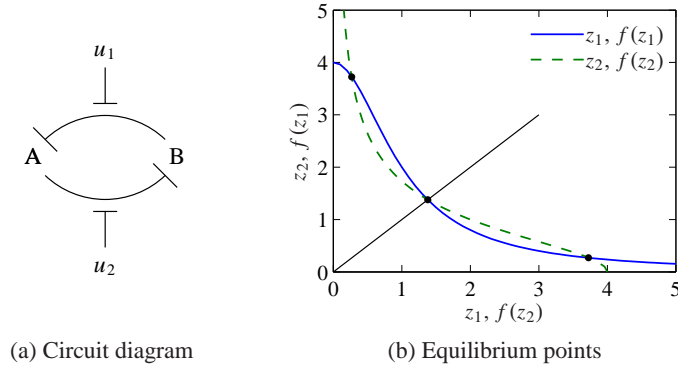

**Figure 4.14:** Stability of a genetic switch. The circuit diagram in (a) represents two proteins that are each repressing the production of the other. The inputs  $u_1$  and  $u_2$  interfere with this repression, allowing the circuit dynamics to be modified. The equilibrium points for this circuit can be determined by the intersection of the two curves shown in (b).

parameters that describe the interconnection between the genes and we have set the external inputs  $u_1$  and  $u_2$  to zero.

The equilibrium points for the system are found by equating the time derivatives to zero. We define

$$f(u) = \frac{\mu}{1 + u^n}, \quad f'(u) = \frac{df}{du} = \frac{-\mu n u^{n-1}}{(1 + u^n)^2},$$

and the equilibrium points are defined as the solutions of the equations

$$z_1 = f(z_2), \quad z_2 = f(z_1).$$

If we plot the curves  $(z_1, f(z_1))$  and  $(f(z_2), z_2)$  on a graph, then these equations will have a solution when the curves intersect, as shown in Figure 4.14b. Because of the shape of the curves, it can be shown that there will always be three solutions: one at  $z_{1e} = z_{2e}$ , one with  $z_{1e} < z_{2e}$  and one with  $z_{1e} > z_{2e}$ . If  $\mu \gg 1$ , then we can show that the solutions are given approximately by

$$z_{1e} \approx \mu, \quad z_{2e} \approx \frac{1}{\mu^{n-1}}; \quad z_{1e} = z_{2e}; \quad z_{1e} \approx \frac{1}{\mu^{n-1}}, \quad z_{2e} \approx \mu. \quad (4.17)$$

To check the stability of the system, we write  $f(u)$  in terms of its Taylor series expansion about  $u_e$ :

$$f(u) = f(u_e) + f'(u_e) \cdot (u - u_e) + f''(u_e) \cdot (u - u_e)^2 + \text{higher-order terms},$$

where  $f'$  represents the first derivative of the function, and  $f''$  the second. Using these approximations, the dynamics can then be written as

$$\frac{dw}{dt} = \begin{bmatrix} -1 & f'(z_{2e}) \\ f'(z_{1e}) & -1 \end{bmatrix} w + \tilde{F}(w),$$

where  $w = z - z_e$  is the shifted state and  $\tilde{F}(w)$  represents quadratic and higher-order

terms.

We now use equation (4.14) to search for a Lyapunov function. Choosing  $Q = I$  and letting  $P \in \mathbb{R}^{2 \times 2}$  have elements  $p_{ij}$ , we search for a solution of the equation

$$\begin{bmatrix} -1 & f'_2 \\ f'_1 & -1 \end{bmatrix} \begin{bmatrix} p_{11} & p_{12} \\ p_{12} & p_{22} \end{bmatrix} + \begin{bmatrix} p_{11} & p_{12} \\ p_{12} & p_{22} \end{bmatrix} \begin{bmatrix} -1 & f'_1 \\ f'_2 & -1 \end{bmatrix} = \begin{bmatrix} -1 & 0 \\ 0 & -1 \end{bmatrix},$$

where  $f'_1 = f'(z_{1e})$  and  $f'_2 = f'(z_{2e})$ . Note that we have set  $p_{21} = p_{12}$  to force  $P$  to be symmetric. Multiplying out the matrices, we obtain

$$\begin{bmatrix} -2p_{11} + 2f'_2 p_{12} & p_{11} f'_1 - 2p_{12} + p_{22} f'_2 \\ p_{11} f'_1 - 2p_{12} + p_{22} f'_2 & -2p_{22} + 2f'_1 p_{12} \end{bmatrix} = \begin{bmatrix} -1 & 0 \\ 0 & -1 \end{bmatrix},$$

which is a set of *linear* equations for the unknowns  $p_{ij}$ . We can solve these linear equations to obtain

$$p_{11} = -\frac{f_1'^2 - f_2' f_1' + 2}{4(f_1' f_2' - 1)}, \quad p_{12} = -\frac{f_1' + f_2'}{4(f_1' f_2' - 1)}, \quad p_{22} = -\frac{f_2'^2 - f_1' f_2' + 2}{4(f_1' f_2' - 1)}.$$

To check that  $V(w) = w^T P w$  is a Lyapunov function, we must verify that  $V(w)$  is positive definite function or equivalently that  $P > 0$ . Since  $P$  is a  $2 \times 2$  symmetric matrix, it has two real eigenvalues  $\lambda_1$  and  $\lambda_2$  that satisfy

$$\lambda_1 + \lambda_2 = \text{trace}(P), \quad \lambda_1 \cdot \lambda_2 = \det(P).$$

In order for  $P$  to be positive definite we must have that  $\lambda_1$  and  $\lambda_2$  are positive, and we thus require that

$$\text{trace}(P) = \frac{f_1'^2 - 2f_2' f_1' + f_2'^2 + 4}{4 - 4f_1' f_2'} > 0, \quad \det(P) = \frac{f_1'^2 - 2f_2' f_1' + f_2'^2 + 4}{16 - 16f_1' f_2'} > 0.$$

We see that  $\text{trace}(P) = 4 \det(P)$  and the numerator of the expressions is just  $(f_1 - f_2)^2 + 4 > 0$ , so it suffices to check the sign of  $1 - f_1' f_2'$ . In particular, for  $P$  to be positive definite, we require that

$$f'(z_{1e}) f'(z_{2e}) < 1.$$

We can now make use of the expressions for  $f'$  defined earlier and evaluate at the approximate locations of the equilibrium points derived in equation (4.17). For the equilibrium points where  $z_{1e} \neq z_{2e}$ , we can show that

$$f'(z_{1e}) f'(z_{2e}) \approx f'(\mu) f'\left(\frac{1}{\mu^{n-1}}\right) = \frac{-\mu n \mu^{n-1}}{(1 + \mu^n)^2} \cdot \frac{-\mu n \mu^{-(n-1)^2}}{1 + \mu^{-n(n-1)}} \approx n^2 \mu^{-n^2+n}.$$

Using  $n = 2$  and  $\mu \approx 200$  from Exercise 2.9, we see that  $f'(z_{1e}) f'(z_{2e}) \ll 1$  and hence  $P$  is a positive definite. This implies that  $V$  is a positive definite function and hence a potential Lyapunov function for the system.

To determine if the system (4.16) is stable, we now compute  $\dot{V}$  at the equilibrium

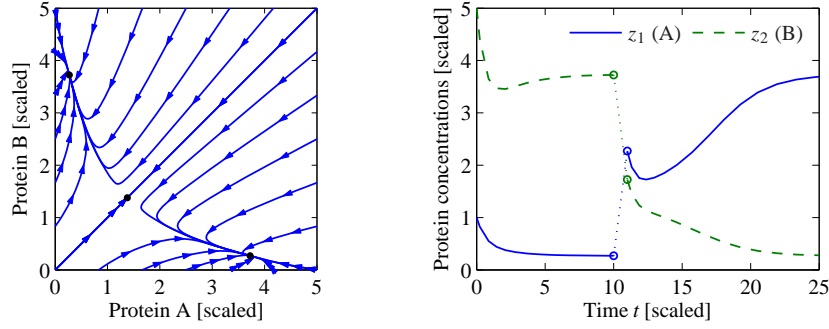

**Figure 4.15:** Dynamics of a genetic switch. The phase portrait on the left shows that the switch has three equilibrium points, corresponding to protein A having a concentration greater than, equal to or less than protein B. The equilibrium point with equal protein concentrations is unstable, but the other equilibrium points are stable. The simulation on the right shows the time response of the system starting from two different initial conditions. The initial portion of the curve corresponds to initial concentrations  $z(0) = (1, 5)$  and converges to the equilibrium where  $z_{1e} < z_{2e}$ . At time  $t = 10$ , the concentrations are perturbed by  $+2$  in  $z_1$  and  $-2$  in  $z_2$ , moving the state into the region of the state space whose solutions converge to the equilibrium point where  $z_{2e} < z_{1e}$ .

point. By construction,

$$\begin{aligned}\dot{V} &= w^T(PA + A^TP)w + \tilde{F}^T(w)Pw + w^TP\tilde{F}(w) \\ &= -w^Tw + \tilde{F}^T(w)Pw + w^TP\tilde{F}(w).\end{aligned}$$

Since all terms in  $\tilde{F}$  are quadratic or higher order in  $w$ , it follows that  $\tilde{F}^T(w)Pw$  and  $w^TP\tilde{F}(w)$  consist of terms that are at least third order in  $w$ . Therefore if  $w$  is sufficiently close to zero, then the cubic and higher-order terms will be smaller than the quadratic terms. Hence, sufficiently close to  $w = 0$ ,  $\dot{V}$  is negative definite, allowing us to conclude that these equilibrium points are both stable.

Figure 4.15 shows the phase portrait and time traces for a system with  $\mu = 4$ , illustrating the bistable nature of the system. When the initial condition starts with a concentration of protein B greater than that of A, the solution converges to the equilibrium point at (approximately)  $(1/\mu^{n-1}, \mu)$ . If A is greater than B, then it goes to  $(\mu, 1/\mu^{n-1})$ . The equilibrium point with  $z_{1e} = z_{2e}$  is unstable.  $\nabla$

More generally, we can investigate what the linear approximation tells about the stability of a solution to a nonlinear equation. The following theorem gives a partial answer for the case of stability of an equilibrium point.

**Theorem 4.3.** *Consider the dynamical system (4.15) with  $F(0) = 0$  and  $\tilde{F}$  such that  $\lim_{\|x\| \rightarrow 0} \|\tilde{F}(x)\|/\|x\| \rightarrow 0$  as  $\|x\| \rightarrow 0$ . If the real parts of all eigenvalues of  $A$  are strictly less than zero, then  $x_e = 0$  is a locally asymptotically stable equilibrium point of equation (4.15).*

This theorem implies that asymptotic stability of the linear approximation implies *local* asymptotic stability of the original nonlinear system. The theorem is very

important for control because it implies that stabilization of a linear approximation of a nonlinear system results in a stable equilibrium for the nonlinear system. The proof of this theorem follows the technique used in Example 4.11. A formal proof can be found in [Kha01].



### Krasovski–Lasalle Invariance Principle

For general nonlinear systems, especially those in symbolic form, it can be difficult to find a positive definite function  $V$  whose derivative is strictly negative definite. The Krasovski–Lasalle theorem enables us to conclude the asymptotic stability of an equilibrium point under less restrictive conditions, namely, in the case where  $\dot{V}$  is negative semidefinite, which is often easier to construct. However, it applies only to time-invariant or periodic systems. This section makes use of some additional concepts from dynamical systems; see Hahn [Hah67] or Khalil [Kha01] for a more detailed description.

We will deal with the time-invariant case and begin by introducing a few more definitions. We denote the solution trajectories of the time-invariant system

$$\frac{dx}{dt} = F(x) \quad (4.18)$$

as  $x(t; a)$ , which is the solution of equation (4.18) at time  $t$  starting from  $a$  at  $t_0 = 0$ . The  $\omega$  limit set of a trajectory  $x(t; a)$  is the set of all points  $z \in \mathbb{R}^n$  such that there exists a strictly increasing sequence of times  $t_n$  such that  $x(t_n; a) \rightarrow z$  as  $n \rightarrow \infty$ . A set  $M \subset \mathbb{R}^n$  is said to be an *invariant set* if for all  $b \in M$ , we have  $x(t; b) \in M$  for all  $t \geq 0$ . It can be proved that the  $\omega$  limit set of every trajectory is closed and invariant. We may now state the Krasovski–Lasalle principle.

**Theorem 4.4** (Krasovski–Lasalle principle). *Let  $V : \mathbb{R}^n \rightarrow \mathbb{R}$  be a locally positive definite function such that on the compact set  $\Omega_r = \{x \in \mathbb{R}^n : V(x) \leq r\}$  we have  $\dot{V}(x) \leq 0$ . Define*

$$S = \{x \in \Omega_r : \dot{V}(x) = 0\}.$$

*As  $t \rightarrow \infty$ , the trajectory tends to the largest invariant set inside  $S$ ; i.e., its  $\omega$  limit set is contained inside the largest invariant set in  $S$ . In particular, if  $S$  contains no invariant sets other than  $x = 0$ , then  $0$  is asymptotically stable.*

Proofs are given in [Kra63] and [LaS60].

Lyapunov functions can often be used to design stabilizing controllers, as is illustrated by the following example, which also illustrates how the Krasovski–Lasalle principle can be applied.

#### Example 4.12 Inverted pendulum

Following the analysis in Example 2.7, an inverted pendulum can be described by the following normalized model:

$$\frac{dx_1}{dt} = x_2, \quad \frac{dx_2}{dt} = \sin x_1 + u \cos x_1, \quad (4.19)$$



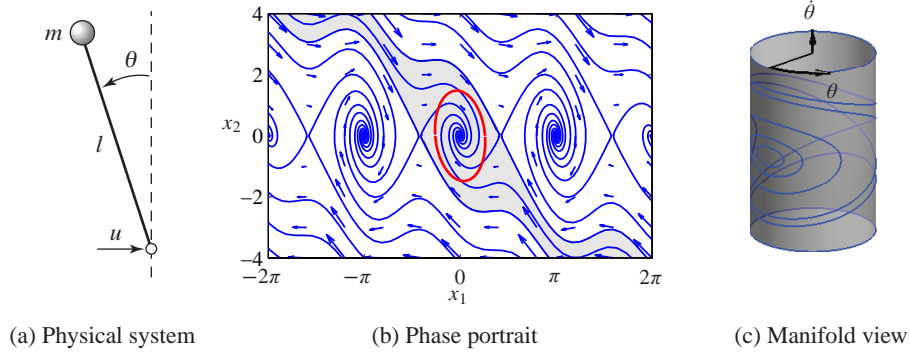

**Figure 4.16:** Stabilized inverted pendulum. A control law applies a force  $u$  at the bottom of the pendulum to stabilize the inverted position (a). The phase portrait (b) shows that the equilibrium point corresponding to the vertical position is stabilized. The shaded region indicates the set of initial conditions that converge to the origin. The ellipse corresponds to a level set of a Lyapunov function  $V(x)$  for which  $V(x) > 0$  and  $\dot{V}(x) < 0$  for all points inside the ellipse. This can be used as an estimate of the region of attraction of the equilibrium point. The actual dynamics of the system evolve on a manifold (c).

where  $x_1$  is the angular deviation from the upright position and  $u$  is the (scaled) acceleration of the pivot, as shown in Figure 4.16a. The system has an equilibrium at  $x_1 = x_2 = 0$ , which corresponds to the pendulum standing upright. This equilibrium is unstable.

To find a stabilizing controller we consider the following candidate for a Lyapunov function:

$$V(x) = (\cos x_1 - 1) + a(1 - \cos^2 x_1) + \frac{1}{2}x_2^2 \approx \left(a - \frac{1}{2}\right)x_1^2 + \frac{1}{2}x_2^2.$$

The Taylor series expansion shows that the function is positive definite near the origin if  $a > 0.5$ . The time derivative of  $V(x)$  is

$$\dot{V} = -\dot{x}_1 \sin x_1 + 2a\dot{x}_1 \sin x_1 \cos x_1 + \dot{x}_2 x_2 = x_2(u + 2a \sin x_1) \cos x_1.$$

Choosing the feedback law

$$u = -2a \sin x_1 - x_2 \cos x_1$$

gives

$$\dot{V} = -x_2^2 \cos^2 x_1.$$

It follows from Lyapunov's theorem that the equilibrium is locally stable. However, since the function is only negative semidefinite, we cannot conclude asymptotic stability using Theorem 4.2. However, note that  $\dot{V} = 0$  implies that  $x_2 = 0$  or  $x_1 = \pi/2 \pm n\pi$ .

If we restrict our analysis to a small neighborhood of the origin  $\Omega_r$ ,  $r \ll \pi/2$ , then we can define

$$S = \{(x_1, x_2) \in \Omega_r : x_2 = 0\}$$

and we can compute the largest invariant set inside  $S$ . For a trajectory to remain in this set we must have  $x_2 = 0$  for all  $t$  and hence  $\dot{x}_2(t) = 0$  as well. Using the dynamics of the system (4.19), we see that  $x_2(t) = 0$  and  $\dot{x}_2(t) = 0$  implies  $x_1(t) = 0$  as well. Hence the largest invariant set inside  $S$  is  $(x_1, x_2) = 0$ , and we can use the Krasovski–Lasalle principle to conclude that the origin is locally asymptotically stable. A phase portrait of the closed loop system is shown in Figure 4.16b.

In the analysis and the phase portrait, we have treated the angle of the pendulum  $\theta = x_1$  as a real number. In fact,  $\theta$  is an angle with  $\theta = 2\pi$  equivalent to  $\theta = 0$ . Hence the dynamics of the system actually evolves on a *manifold* (smooth surface) as shown in Figure 4.16c. Analysis of nonlinear dynamical systems on manifolds is more complicated, but uses many of the same basic ideas presented here.  $\nabla$



## 4.5 Parametric and Nonlocal Behavior

Most of the tools that we have explored are focused on the local behavior of a fixed system near an equilibrium point. In this section we briefly introduce some concepts regarding the global behavior of nonlinear systems and the dependence of a system's behavior on parameters in the system model.

### Regions of Attraction

To get some insight into the behavior of a nonlinear system we can start by finding the equilibrium points. We can then proceed to analyze the local behavior around the equilibria. The behavior of a system near an equilibrium point is called the *local* behavior of the system.

The solutions of the system can be very different far away from an equilibrium point. This is seen, for example, in the stabilized pendulum in Example 4.12. The inverted equilibrium point is stable, with small oscillations that eventually converge to the origin. But far away from this equilibrium point there are trajectories that converge to other equilibrium points or even cases in which the pendulum swings around the top multiple times, giving very long oscillations that are topologically different from those near the origin.

To better understand the dynamics of the system, we can examine the set of all initial conditions that converge to a given asymptotically stable equilibrium point. This set is called the *region of attraction* for the equilibrium point. An example is shown by the shaded region of the phase portrait in Figure 4.16b. In general, computing regions of attraction is difficult. However, even if we cannot determine the region of attraction, we can often obtain patches around the stable equilibria that are attracting. This gives partial information about the behavior of the system.

One method for approximating the region of attraction is through the use of Lyapunov functions. Suppose that  $V$  is a local Lyapunov function for a system around an equilibrium point  $x_0$ . Let  $\Omega_r$  be a set on which  $V(x)$  has a value less than  $r$ ,

$$\Omega_r = \{x \in \mathbb{R}^n : V(x) \leq r\},$$

and suppose that  $\dot{V}(x) \leq 0$  for all  $x \in \Omega_r$ , with equality only at the equilibrium point  $x_0$ . Then  $\Omega_r$  is inside the region of attraction of the equilibrium point. Since this approximation depends on the Lyapunov function and the choice of Lyapunov function is not unique, it can sometimes be a very conservative estimate.

It is sometimes the case that we can find a Lyapunov function  $V$  such that  $V$  is positive definite and  $\dot{V}$  is negative (semi-) definite for all  $x \in \mathbb{R}^n$ . In this case it can be shown that the region of attraction for the equilibrium point is the entire state space, and the equilibrium point is said to be *globally stable*.

#### Example 4.13 Stabilized inverted pendulum

Consider again the stabilized inverted pendulum from Example 4.12. The Lyapunov function for the system was

$$V(x) = (\cos x_1 - 1) + a(1 - \cos^2 x_1) + \frac{1}{2}x_2^2,$$

and  $\dot{V}$  was negative semidefinite for all  $x$  and nonzero when  $x_1 \neq \pm\pi/2$ . Hence for any  $x$  such that  $|x_2| < \pi/2$ ,  $V(x) > 0$  will be inside the invariant set defined by the level curves of  $V(x)$ . One of these level sets is shown in Figure 4.16b.  $\nabla$

### Bifurcations

Another important property of nonlinear systems is how their behavior changes as the parameters governing the dynamics change. We can study this in the context of models by exploring how the location of equilibrium points, their stability, their regions of attraction and other dynamic phenomena, such as limit cycles, vary based on the values of the parameters in the model.

Consider a differential equation of the form

$$\frac{dx}{dt} = F(x, \mu), \quad x \in \mathbb{R}^n, \mu \in \mathbb{R}^k, \quad (4.20)$$

where  $x$  is the state and  $\mu$  is a set of parameters that describe the family of equations. The equilibrium solutions satisfy

$$F(x, \mu) = 0,$$

and as  $\mu$  is varied, the corresponding solutions  $x_e(\mu)$  can also vary. We say that the system (4.20) has a *bifurcation* at  $\mu = \mu^*$  if the behavior of the system changes qualitatively at  $\mu^*$ . This can occur either because of a change in stability type or a change in the number of solutions at a given value of  $\mu$ .

#### Example 4.14 Predator–prey

Consider the predator–prey system described in Section 3.7. The dynamics of the system are given by

$$\frac{dH}{dt} = rH \left(1 - \frac{H}{k}\right) - \frac{aHL}{c+H}, \quad \frac{dL}{dt} = b\frac{aHL}{c+H} - dL, \quad (4.21)$$

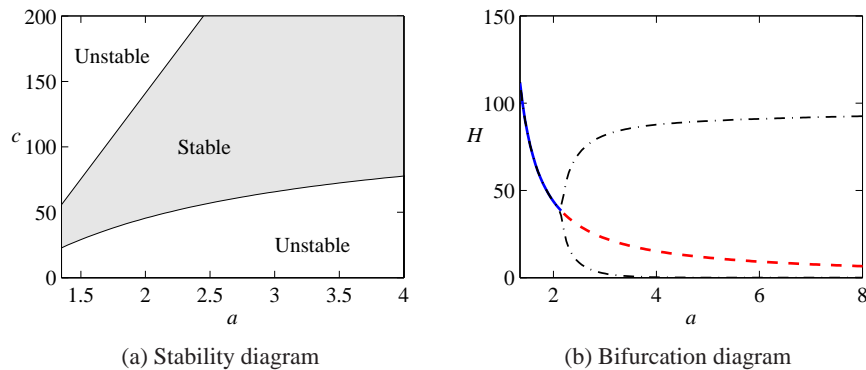

**Figure 4.17:** Bifurcation analysis of the predator–prey system. (a) Parametric stability diagram showing the regions in parameter space for which the system is stable. (b) Bifurcation diagram showing the location and stability of the equilibrium point as a function of  $a$ . The solid line represents a stable equilibrium point, and the dashed line represents an unstable equilibrium point. The dashed-dotted lines indicate the upper and lower bounds for the limit cycle at that parameter value (computed via simulation). The nominal values of the parameters in the model are  $a = 3.2$ ,  $b = 0.6$ ,  $c = 50$ ,  $d = 0.56$ ,  $k = 125$  and  $r = 1.6$ .

where  $H$  and  $L$  are the numbers of hares (prey) and lynxes (predators) and  $a$ ,  $b$ ,  $c$ ,  $d$ ,  $k$  and  $r$  are parameters that model a given predator–prey system (described in more detail in Section 3.7). The system has an equilibrium point at  $H_e > 0$  and  $L_e > 0$  that can be found numerically.

To explore how the parameters of the model affect the behavior of the system, we choose to focus on two specific parameters of interest:  $a$ , the interaction coefficient between the populations and  $c$ , a parameter affecting the prey consumption rate. Figure 4.17a is a numerically computed *parametric stability diagram* showing the regions in the chosen parameter space for which the equilibrium point is stable (leaving the other parameters at their nominal values). We see from this figure that for certain combinations of  $a$  and  $c$  we get a stable equilibrium point, while at other values this equilibrium point is unstable.

Figure 4.17b is a numerically computed *bifurcation diagram* for the system. In this plot, we choose one parameter to vary ( $a$ ) and then plot the equilibrium value of one of the states ( $H$ ) on the vertical axis. The remaining parameters are set to their nominal values. A solid line indicates that the equilibrium point is stable; a dashed line indicates that the equilibrium point is unstable. Note that the stability in the bifurcation diagram matches that in the parametric stability diagram for  $c = 50$  (the nominal value) and  $a$  varying from 1.35 to 4. For the predator–prey system, when the equilibrium point is unstable, the solution converges to a stable limit cycle. The amplitude of this limit cycle is shown by the dashed-dotted line in Figure 4.17b.

▽

A particular form of bifurcation that is very common when controlling linear systems is that the equilibrium remains fixed but the stability of the equilibrium

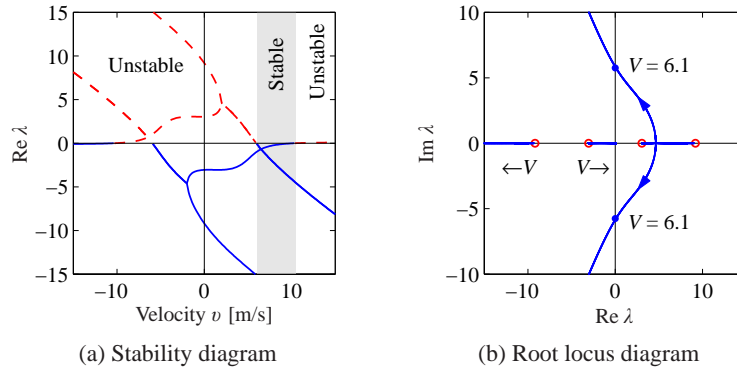

**Figure 4.18:** Stability plots for a bicycle moving at constant velocity. The plot in (a) shows the real part of the system eigenvalues as a function of the bicycle velocity  $v$ . The system is stable when all eigenvalues have negative real part (shaded region). The plot in (b) shows the locus of eigenvalues on the complex plane as the velocity  $v$  is varied and gives a different view of the stability of the system. This type of plot is called a *root locus diagram*.

changes as the parameters are varied. In such a case it is revealing to plot the eigenvalues of the system as a function of the parameters. Such plots are called *root locus diagrams* because they give the locus of the eigenvalues when parameters change. Bifurcations occur when parameter values are such that there are eigenvalues with zero real part. Computing environments such LabVIEW, MATLAB and Mathematica have tools for plotting root loci.

#### Example 4.15 Root locus diagram for a bicycle model

Consider the linear bicycle model given by equation (3.7) in Section 3.2. Introducing the state variables  $x_1 = \varphi$ ,  $x_2 = \delta$ ,  $x_3 = \dot{\varphi}$  and  $x_4 = \dot{\delta}$  and setting the steering torque  $T = 0$ , the equations can be written as

$$\frac{dx}{dt} = \begin{bmatrix} 0 & I \\ -M^{-1}(K_0 + K_2v_0^2) & -M^{-1}Cv_0 \end{bmatrix} x =: Ax,$$

where  $I$  is a  $2 \times 2$  identity matrix and  $v_0$  is the velocity of the bicycle. Figure 4.18a shows the real parts of the eigenvalues as a function of velocity. Figure 4.18b shows the dependence of the eigenvalues of  $A$  on the velocity  $v_0$ . The figures show that the bicycle is unstable for low velocities because two eigenvalues are in the right half-plane. As the velocity increases, these eigenvalues move into the left half-plane, indicating that the bicycle becomes self-stabilizing. As the velocity is increased further, there is an eigenvalue close to the origin that moves into the right half-plane, making the bicycle unstable again. However, this eigenvalue is small and so it can easily be stabilized by a rider. Figure 4.18a shows that the bicycle is self-stabilizing for velocities between 6 and 10 m/s.  $\nabla$

Parametric stability diagrams and bifurcation diagrams can provide valuable insights into the dynamics of a nonlinear system. It is usually necessary to carefully choose the parameters that one plots, including combining the natural parameters

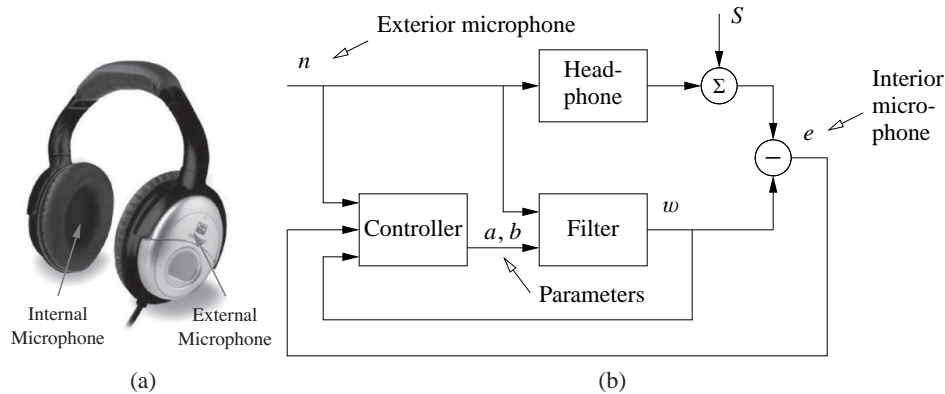

**Figure 4.19:** Headphones with noise cancellation. Noise is sensed by the exterior microphone (a) and sent to a filter in such a way that it cancels the noise that penetrates the head phone (b). The filter parameters  $a$  and  $b$  are adjusted by the controller.  $S$  represents the input signal to the headphones.

of the system to eliminate extra parameters when possible. Computer programs such as AUTO, LOCBIF and XPPAUT provide numerical algorithms for producing stability and bifurcation diagrams.

### Design of Nonlinear Dynamics Using Feedback

In most of the text we will rely on linear approximations to design feedback laws that stabilize an equilibrium point and provide a desired level of performance. However, for some classes of problems the feedback controller must be nonlinear to accomplish its function. By making use of Lyapunov functions we can often design a nonlinear control law that provides stable behavior, as we saw in Example 4.12.

One way to systematically design a nonlinear controller is to begin with a candidate Lyapunov function  $V(x)$  and a control system  $\dot{x} = f(x, u)$ . We say that  $V(x)$  is a *control Lyapunov function* if for every  $x$  there exists a  $u$  such that  $\dot{V}(x) = \frac{\partial V}{\partial x} f(x, u) < 0$ . In this case, it may be possible to find a function  $\alpha(x)$  such that  $u = \alpha(x)$  stabilizes the system. The following example illustrates the approach.

#### Example 4.16 Noise cancellation

Noise cancellation is used in consumer electronics and in industrial systems to reduce the effects of noise and vibrations. The idea is to locally reduce the effect of noise by generating opposing signals. A pair of headphones with noise cancellation such as those shown in Figure 4.19a is a typical example. A schematic diagram of the system is shown in Figure 4.19b. The system has two microphones, one outside the headphones that picks up exterior noise  $n$  and another inside the headphones that picks up the signal  $e$ , which is a combination of the desired signal and the external noise that penetrates the headphone. The signal from the exterior microphone is filtered and sent to the headphones in such a way that it cancels the external noise

that penetrates into the headphones. The parameters of the filter are adjusted by a feedback mechanism to make the noise signal in the internal microphone as small as possible. The feedback is inherently nonlinear because it acts by changing the parameters of the filter.

To analyze the system we assume for simplicity that the propagation of external noise into the headphones is modeled by a first-order dynamical system described by

$$\frac{dz}{dt} = a_0z + b_0n, \quad (4.22)$$

where  $z$  is the sound level and the parameters  $a_0 < 0$  and  $b_0$  are not known. Assume that the filter is a dynamical system of the same type:

$$\frac{dw}{dt} = aw + bn.$$

We wish to find a controller that updates  $a$  and  $b$  so that they converge to the (unknown) parameters  $a_0$  and  $b_0$ . Introduce  $x_1 = e = w - z$ ,  $x_2 = a - a_0$  and  $x_3 = b - b_0$ ; then

$$\frac{dx_1}{dt} = a_0(w - z) + (a - a_0)w + (b - b_0)n = a_0x_1 + x_2w + x_3n. \quad (4.23)$$

We will achieve noise cancellation if we can find a feedback law for changing the parameters  $a$  and  $b$  so that the error  $e$  goes to zero. To do this we choose

$$V(x_1, x_2, x_3) = \frac{1}{2}(ax_1^2 + x_2^2 + x_3^2)$$

as a candidate Lyapunov function for (4.23). The derivative of  $V$  is

$$\dot{V} = ax_1\dot{x}_1 + x_2\dot{x}_2 + x_3\dot{x}_3 = \alpha a_0x_1^2 + x_2(\dot{x}_2 + awx_1) + x_3(\dot{x}_3 + anx_1).$$

Choosing

$$\dot{x}_2 = -awx_1 = -awe, \quad \dot{x}_3 = -anx_1 = -ane, \quad (4.24)$$

we find that  $\dot{V} = \alpha a_0x_1^2 < 0$ , and it follows that the quadratic function will decrease as long as  $e = x_1 = w - z \neq 0$ . The nonlinear feedback (4.24) thus attempts to change the parameters so that the error between the signal and the noise is small. Notice that feedback law (4.24) does not use the model (4.22) explicitly.

A simulation of the system is shown in Figure 4.20. In the simulation we have represented the signal as a pure sinusoid and the noise as broad band noise. The figure shows the dramatic improvement with noise cancellation. The sinusoidal signal is not visible without noise cancellation. The filter parameters change quickly from their initial values  $a = b = 0$ . Filters of higher order with more coefficients are used in practice.  $\nabla$

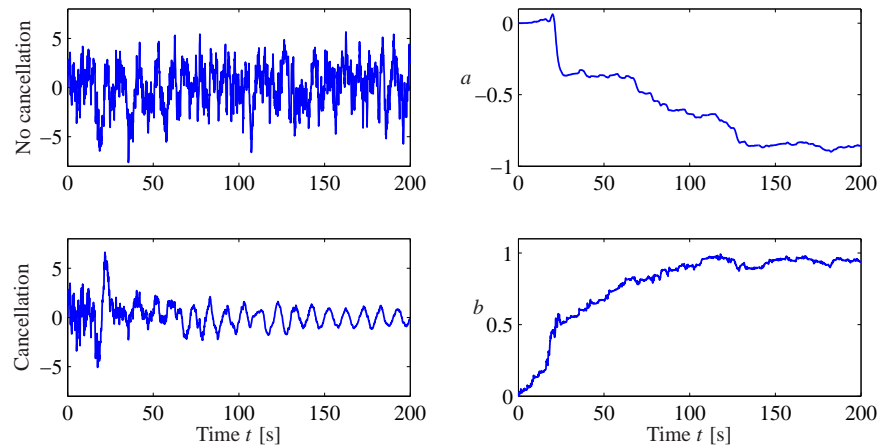

**Figure 4.20:** Simulation of noise cancellation. The top left figure shows the headphone signal without noise cancellation, and the bottom left figure shows the signal with noise cancellation. The right figures show the parameters  $a$  and  $b$  of the filter.

## 4.6 Further Reading

The field of dynamical systems has a rich literature that characterizes the possible features of dynamical systems and describes how parametric changes in the dynamics can lead to topological changes in behavior. Readable introductions to dynamical systems are given by Strogatz [Str94] and the highly illustrated text by Abraham and Shaw [AS82]. More technical treatments include Andronov, Vitt and Khaikin [AVK87], Guckenheimer and Holmes [GH83] and Wiggins [Wig90]. For students with a strong interest in mechanics, the texts by Arnold [Arn87] and Marsden and Ratiu [MR94] provide an elegant approach using tools from differential geometry. Finally, good treatments of dynamical systems methods in biology are given by Wilson [Wil99] and Ellner and Guckenheimer [EG05]. There is a large literature on Lyapunov stability theory, including the classic texts by Malkin [Mal59], Hahn [Hah67] and Krasovski [Kra63]. We highly recommend the comprehensive treatment by Khalil [Kha01].

## Exercises

**4.1** (Time-invariant systems) Show that if we have a solution of the differential equation (4.1) given by  $x(t)$  with initial condition  $x(t_0) = x_0$ , then  $\tilde{x}(\tau) = x(t - t_0)$  is a solution of the differential equation

$$\frac{d\tilde{x}}{d\tau} = F(\tilde{x})$$

with initial condition  $\tilde{x}(0) = x_0$ , where  $\tau = t - t_0$ .

**4.2** (Flow in a tank) A cylindrical tank has cross section  $A$  m<sup>2</sup>, effective outlet area  $a$  m<sup>2</sup> and inflow  $q_{in}$  m<sup>3</sup>/s. An energy balance shows that the outlet velocity is



$v = \sqrt{2gh}$  m/s, where  $g$  m/s<sup>2</sup> is the acceleration of gravity and  $h$  is the distance between the outlet and the water level in the tank (in meters). Show that the system can be modeled by

$$\frac{dh}{dt} = -\frac{a}{A}\sqrt{2gh} - \frac{1}{A}q_{in}, \quad q_{out} = a\sqrt{2gh}.$$

Use the parameters  $A = 0.2$ ,  $a = 0.01$ . Simulate the system when the inflow is zero and the initial level is  $h = 0.2$ . Do you expect any difficulties in the simulation?

**4.3** (Cruise control) Consider the cruise control system described in Section 3.1. Generate a phase portrait for the closed loop system on flat ground ( $\theta = 0$ ), in third gear, using a PI controller (with  $k_p = 0.5$  and  $k_i = 0.1$ ),  $m = 1000$  kg and desired speed 20 m/s. Your system model should include the effects of saturating the input between 0 and 1.

**4.4** (Lyapunov functions) Consider the second-order system

$$\frac{dx_1}{dt} = -ax_1, \quad \frac{dx_2}{dt} = -bx_1 - cx_2,$$

where  $a, b, c > 0$ . Investigate whether the functions

$$V_1(x) = \frac{1}{2}x_1^2 + \frac{1}{2}x_2^2, \quad V_2(x) = \frac{1}{2}x_1^2 + \frac{1}{2}\left(x_2 + \frac{b}{c-a}x_1\right)^2$$

are Lyapunov functions for the system and give any conditions that must hold.

**4.5** (Damped spring–mass system) Consider a damped spring–mass system with dynamics 

$$m\ddot{q} + c\dot{q} + kq = 0.$$

A natural candidate for a Lyapunov function is the total energy of the system, given by

$$V = \frac{1}{2}m\dot{q}^2 + \frac{1}{2}kq^2.$$

Use the Krasovski–Lasalle theorem to show that the system is asymptotically stable.

**4.6** (Electric generator) The following simple model for an electric generator connected to a strong power grid was given in Exercise 2.7:

$$J\frac{d^2\varphi}{dt^2} = P_m - P_e = P_m - \frac{EV}{X}\sin\varphi.$$

The parameter

$$a = \frac{P_{\max}}{P_m} = \frac{EV}{XP_m} \quad (4.25)$$

is the ratio between the maximum deliverable power  $P_{\max} = EV/X$  and the mechanical power  $P_m$ .

(a) Consider  $a$  as a bifurcation parameter and discuss how the equilibria depend on  $a$ .

(b) For  $a > 1$ , show that there is a center at  $\varphi_0 = \arcsin(1/a)$  and a saddle at  $\varphi = \pi - \varphi_0$ .

(c) Show that if  $P_m/J = 1$  there is a solution through the saddle that satisfies

$$\frac{1}{2} \left( \frac{d\varphi}{dt} \right)^2 - \varphi + \varphi_0 - a \cos \varphi - \sqrt{a^2 - 1} = 0. \quad (4.26)$$

Use simulation to show that the stability region is the interior of the area enclosed by this solution. Investigate what happens if the system is in equilibrium with a value of  $a$  that is slightly larger than 1 and  $a$  suddenly decreases, corresponding to the reactance of the line suddenly increasing.

**4.7** (Lyapunov equation) Show that Lyapunov equation (4.14) always has a solution if all of the eigenvalues of  $A$  are in the left half-plane. (Hint: Use the fact that the Lyapunov equation is linear in  $P$  and start with the case where  $A$  has distinct eigenvalues.)

**4.8** (Congestion control) Consider the congestion control problem described in Section 3.4. Confirm that the equilibrium point for the system is given by equation (3.21) and compute the stability of this equilibrium point using a linear approximation.

**4.9** (Swinging up a pendulum) Consider the inverted pendulum, discussed in Example 4.4, that is described by

$$\ddot{\theta} = \sin \theta + u \cos \theta,$$

where  $\theta$  is the angle between the pendulum and the vertical and the control signal  $u$  is the acceleration of the pivot. Using the energy function

$$V(\theta, \dot{\theta}) = \cos \theta - 1 + \frac{1}{2} \dot{\theta}^2,$$

show that the state feedback  $u = k(V_0 - V)\dot{\theta} \cos \theta$  causes the pendulum to “swing up” to the upright position.

**4.10** (Root locus diagram) Consider the linear system

$$\frac{dx}{dt} = \begin{bmatrix} 0 & 1 \\ 0 & -3 \end{bmatrix} x + \begin{bmatrix} -1 \\ 4 \end{bmatrix} u, \quad y = \begin{bmatrix} 1 & 0 \end{bmatrix} x,$$

with the feedback  $u = -ky$ . Plot the location of the eigenvalues as a function the parameter  $k$ .



**4.11** (Discrete-time Lyapunov function) Consider a nonlinear discrete-time system with dynamics  $x[k+1] = f(x[k])$  and equilibrium point  $x_e = 0$ . Suppose there exists a smooth, positive definite function  $V : \mathbb{R}^n \rightarrow \mathbb{R}$  such that  $V(f(x)) - V(x) < 0$  for  $x \neq 0$  and  $V(0) = 0$ . Show that  $x_e = 0$  is (locally) asymptotically stable.

**4.12** (Operational amplifier oscillator) An op amp circuit for an oscillator was shown in Exercise 3.5. The oscillatory solution for that linear circuit was stable but not asymptotically stable. A schematic of a modified circuit that has nonlinear elements is shown in the figure below.

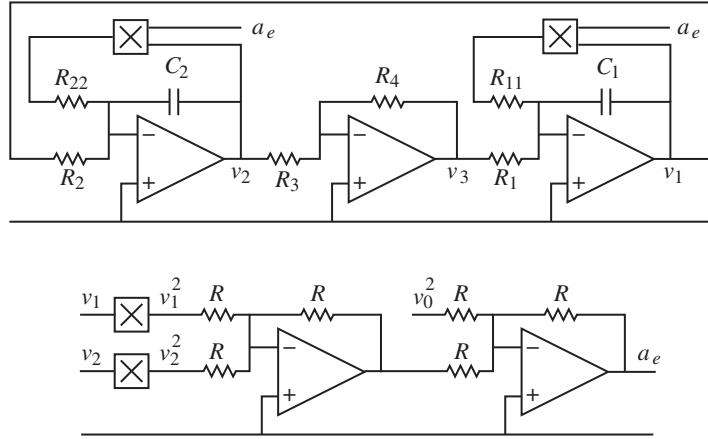

The modification is obtained by making a feedback around each operational amplifier that has capacitors using multipliers. The signal  $a_e = v_1^2 + v_2^2 - v_0^2$  is the amplitude error. Show that the system is modeled by

$$\begin{aligned} \frac{dv_1}{dt} &= \frac{R_4}{R_1 R_3 C_1} v_2 + \frac{1}{R_{11} C_1} v_1 (v_0^2 - v_1^2 - v_2^2), \\ \frac{dv_2}{dt} &= -\frac{1}{R_2 C_2} v_1 + \frac{1}{R_{22} C_2} v_2 (v_0^2 - v_1^2 - v_2^2). \end{aligned}$$

Show that the circuit gives an oscillation with a stable limit cycle with amplitude  $v_0$ . (Hint: Use the results of Example 4.8.)

**4.13** (Self-activating genetic circuit) Consider the dynamics of a genetic circuit that implements *self-activation*: the protein produced by the gene is an activator for the protein, thus stimulating its own production through positive feedback. Using the models presented in Example 2.13, the dynamics for the system can be written as

$$\frac{dm}{dt} = \frac{\alpha p^2}{1 + kp^2} + \alpha_0 - \gamma m, \quad \frac{dp}{dt} = \beta m - \delta p, \quad (4.27)$$

for  $p, m \geq 0$ . Find the equilibrium points for the system and analyze the local stability of each using Lyapunov analysis.

**4.14** (Diagonal systems) Let  $A \in \mathbb{R}^{n \times n}$  be a square matrix with real eigenvalues  $\lambda_1, \dots, \lambda_n$  and corresponding eigenvectors  $v_1, \dots, v_n$ .

(a) Show that if the eigenvalues are distinct ( $\lambda_i \neq \lambda_j$  for  $i \neq j$ ), then  $v_i \neq v_j$  for  $i \neq j$ .

(b) Show that the eigenvectors form a basis for  $\mathbb{R}^n$  so that any vector  $x$  can be written as  $x = \sum \alpha_i v_i$  for  $\alpha_i \in \mathbb{R}$ .

(c) Let  $T = \begin{bmatrix} v_1 & v_2 & \dots & v_n \end{bmatrix}$  and show that  $T^{-1}AT$  is a diagonal matrix of the form (4.8).

(d) Show that if some of the  $\lambda_i$  are complex numbers, then  $A$  can be written as

$$A = \begin{bmatrix} \Lambda_1 & & 0 \\ & \ddots & \\ 0 & & \Lambda_k \end{bmatrix} \quad \text{where} \quad \Lambda_i = \lambda \in \mathbb{R} \quad \text{or} \quad \Lambda_i = \begin{bmatrix} \sigma & \omega \\ -\omega & \sigma \end{bmatrix}.$$

in an appropriate set of coordinates.

This form of the dynamics of a linear system is often referred to as *modal form*.

**4.15** (Furuta pendulum) The Furuta pendulum, an inverted pendulum on a rotating arm, is shown to the left in the figure below.

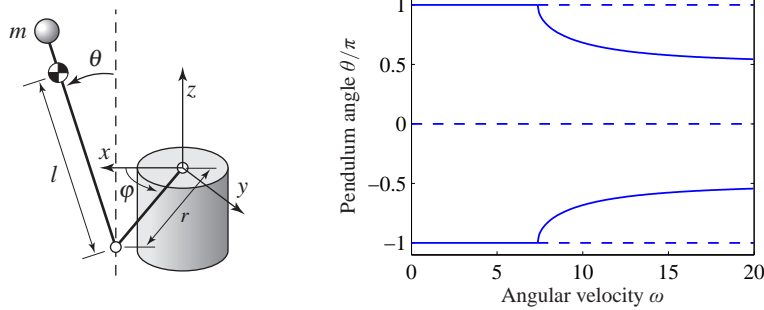

Consider the situation when the pendulum arm is spinning with constant rate. The system has multiple equilibrium points that depend on the angular velocity  $\omega$ , as shown in the bifurcation diagram on the right.

The equations of motion for the system are given by

$$J_p \ddot{\theta} - J_p \omega_0^2 \sin \theta \cos \theta - m_p g l \sin \theta = 0,$$

where  $J_p$  is the moment of inertia of the pendulum with respect to its pivot,  $m_p$  is the pendulum mass,  $l$  is the distance between the pivot and the center of mass of the pendulum and  $\omega_0$  is the rate of rotation of the arm.

(a) Determine the equilibria for the system and the condition(s) for stability of each equilibrium point (in terms of  $\omega_0$ ).

(b) Consider the angular velocity as a bifurcation parameter and verify the bifurcation diagram given above. This is an example of a *pitchfork bifurcation*.

**4.16** (Routh-Hurwitz criterion) Consider a linear differential equation with the characteristic polynomial

$$\lambda(s) = s^2 + a_1 s + a_2, \quad \lambda(s) = s^3 + a_1 s^2 + a_2 s + a_3.$$

Show that the system is asymptotically stable if and only if all the coefficients  $a_i$  are positive and if  $a_1 a_2 > a_3$ . This is a special case of a more general set of criteria known as the Routh-Hurwitz criterion.